

# COLLECTION 2024

KALENDARZE I NOTESY / CALENDARS AND NOTEBOOKS

pier Luigi<sup>®</sup>  
1 9 9 3

ONE<sup>st</sup>  
BOOK



**GIFT**brand  
K A L E N D A R Z E

# KONTAKT

**E-MAIL:** KONTAKT@GIFTBRAND.PL

---

**TEL.** 607 382 099

---

**TEL.** 570 549 500

---



**PAPIER Z KAMIENIA / STONE PAPER**



**PAPIER Z TRAWY / GRASS PAPER**



**PAPIER Z RECYKLINGU / RECYCLED PAPER**

**WZORY PAPIERÓW EKOLOGICZNYCH PREZENTUJEMY NA KOŃCU KATALOGU**  
MODELS OF ECOLOGICAL PAPERS ARE PRESENTED AT THE END OF THE CATALOGUE

## SPIS TREŚCI / TABLE OF CONTENTS

DRZEWO ZA KALENDARZ / A TREE FOR A CALENDAR <b>NEW</b>	04
PAPIER Z NASIONAMI / PAPER WITH SEEDS	06
METODY ZNAKOWANIA / DEBOSSING METHODS	08
rPET	14
RE-COVER	16
QUERK	18
NATURA	20
SAVANA	22
GAMBO <b>NEW</b>	24
COLORADO <b>NEW</b>	26
CROSS	28
PIKO	30
METALLIC PRINT	32
GUMA	34
VIVELA	36
CANVAS	38
CANVAS LINE	40
CANVAS - SPINE / HORIZONT	42
KRAFT	44
DURO	45
IMAGE	46
FLESZ	47
IDEO	48
IDEO EXCLUSIVE	50
ZESTAWY PREMIUM / PREMIUM SETS	52
CARBON	54
ITALIANO - SKÓRA / LEATHER	56
PATKI / SYNTHETIC LEATHER TABS	58
KALENDARZ BIURKOWY STOJĄCY I LEŻĄCY / LYING AND STANDING DESK CALENDAR	60
OPAKOWANIA / PACKAGINGS	62
DODATKI / ADD-ONS	64
PROJEKT AUTORSKI / CUSTOMISED DESIGN	76
ZNAKOWANIE OPRAW / COVERS MARKING METHODS	77
ZESTAWIENIE ROKU / YEAR DESIGN	78
ŁĄCZENIE OPRAW / COVER COMBINATIONS	83
MATRYCE WIELKOFORMATOWE / LARGE FORMAT STAMPS	84
BLOKI KALENDARZY DZIENNYCH / DAILY CALENDARS LAYOUTS	86
BLOKI KALENDARZY TYGODNIOWYCH / WEEKLY CALENDARS LAYOUTS	90
BLOKI NOTESOWE / NOTEBOOKS LAYOUTS	102
GADŻETY ECO / ECO GADGETS	104
ROZGAŁĘŻNIKI USB / USB CHARGING CABLES	116
POWERBANKI / POWERBANKS	120
ENERGY SET	121
POWER SET	124
WHITE BOX & BLACK BOX	126
ZESTAWIENIE BLOKÓW / LIST OF BLOCKS	128



**POSADŹ  
Z NAMI  
DRZEWO!**

PLANT  
A TREE  
WITH US!

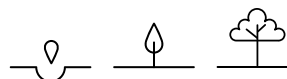

**PRZYCZYŃ SIĘ  
DO OCHRONY  
ŚRODOWISKA  
NATURALNEGO  
I ZRÓWNOWAŻONEGO  
ROZWOJU**

CONTRIBUTE  
TO PROTECTING  
THE NATURAL  
ENVIRONMENT  
AND SUSTAINABLE  
DEVELOPMENT

**100** KALENDARZY /  
CALENDARS



=

**1** DRZEWO /  
TREE



DZIĘKI PROGRAMOWI **POSADZIMY.PL** ZA KAŻDE ZAKUPIONE U NAS 100 KALENDARZY, ZASADZIMY 1 DRZEWO. / THANKS TO POSADZIMY.PL PROGRAMME, FOR EVERY 100 CALENDARS PURCHASED FROM US, WE WILL PLANT 1 TREE.

**N1**  
**NASIONA**  
**SOSNY**  
PINE SEEDS



1

2

INSPIRACJA / INSPIRATION

rok / year design

12

oprawa / cover

1 - CANVAS, 2 - NATURA

znakowanie / marking method

łtłczenie, szycie kreatywne / debossing, creative stitching

dodatek / add-on

N1 **NEW**



**PAPIER  
Z NASIONAMI  
ZAWIERA  
MIX  
KWIATÓW POLNYCH**

PAPER  
WITH SEEDS  
CONTAINS  
A MIX OF  
FIELD FLOWERS

MAK POLNY / FIELD POPPY  
STOKROTKA / DAISY  
NIEZAPOMINAJKA / FORGET-ME-NOT  
FIRLETKA / CATCHFLY



**POSADŹ,  
PODLEJ,  
PIELĘGNUJ!**

PLANT, WATER, CARE FOR!



wklejka / insert page

**KSZTAŁTY / SHAPES**

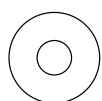

1 - Ø 90 mm



3 - 95 × 80 mm



5 - 68 × 90 mm



7 - 95 × 80 mm

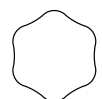

2 - 80 × 90 mm



4 - 95 × 60 mm



6 - 90 × 90 mm



8 - 90 × 90 mm

A low-angle, upward-looking photograph of the stadium's steel and concrete structure against a bright sky. The image features a large, curved steel beam in the foreground, with several vertical support columns and cables extending upwards. The overall color palette is dominated by the metallic tones of the stadium and a bright, almost white sky.

STADION  
ŚLĄSKI

# CHORZÓW

PAPIER Z NASIONAMI  
PAPER WITH SEEDS

## METODY ZNAKOWANIA / DEBOSSING METHODS



### INSPIRACJA / INSPIRATION

rok / year design

oprawa / cover

znakowanie / marking method

dodatek / add-on

drukowany / printed

RE-COVER

1 2 – druk / print

1 – M19



**STWÓRZ  
WŁASNĄ  
KREACJĘ**

CREATE YOUR  
OWN DESIGN



3

4

#### INSPIRACJA / INSPIRATION

rok / year design

3 – 2B, 4 – drukowany / printed

oprawa / cover

3 – IDEO, 4 – GUMA

znakowanie / marking method

3 – druk, tłoczenie / print, debossing, 4 – druk / print

dodatek / add-on

4 – element autorski 3D / 3D customised element **NEW**

## METODY ZNAKOWANIA / DEBOSSING METHODS



### INSPIRACJA / INSPIRATION

rok / year design

**1** - 20, **2** - B1 **NEW**

oprawa / cover

**1** - IDEO, **2** - GAMBO

znakowanie / marking method

**1** - **tłoczenie wielkoformatowe** / large format debossing\*  
**2** - **tłoczenie wielkoformatowe, szycie kreatywne** /  
large format debossing\*, creative stitching

dodatek / add-on

**1** - **finochrom autorski** / customised finochrome

\*MATRYCE WIELKOFORMATOWE DO TŁOCZEŃ ZAMIESZCZONE SĄ NA STRONIE 84. / LARGE FORMAT STAMPS FOR THE DEBOSSING ARE AVAILABLE FROM PAGE 84.



INSPIRACJA / INSPIRATION

rok / year design

M4

oprawa / cover

IDEO

znakowanie / marking method

**łtczenie wielkoformatowe autorskie, łtczenie foli, szycie kreatywne /**  
 customised large format debossing, foil debossing, creative stitching

dodatek / add-on

M17B



INSPIRACJA / INSPIRATION

rok / year design

**2** – 7

oprawa / cover

**1** – IDEO, **2** – CROSS

znakowanie / marking method

**1** – szycie kreatywne **LINE 2**, tłoczenie, grawer /  
creative stitching **LINE 2**, debossing, engraving

**2** – obszycie, tłoczenie, grawer / stitching, debossing, engraving

dodatek / add-on

**1** – M21, **2** – M11

## SUBTELNY PRZEKAZ

SUBTLE  
MESSAGE



### INSPIRACJA / INSPIRATION

rok / year design

**3** – M3, **4** – 2B

oprawa / cover

**GUMA**

znakowanie / marking method

**4** – tłoczenie, grawer / debossing, engraving

dodatek / add-on

**3** – gumka pozioma płaska 10 mm / 10 mm horizontal elastic band

**4** – gumka pionowa płaska 10 mm + M15, szlufka na długopis /  
10 mm vertical elastic band + M15, elastic pen holder

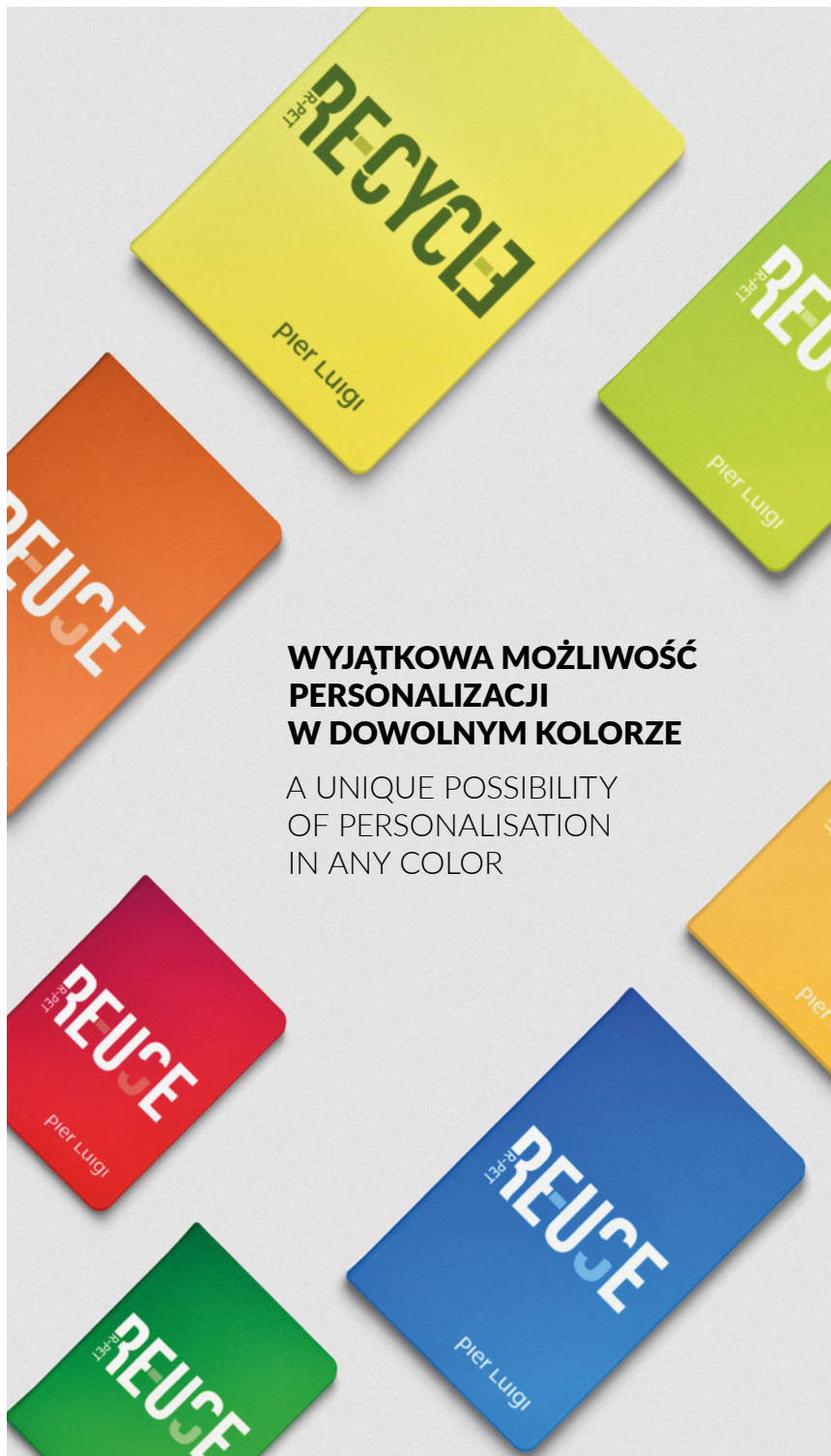

**WYJĄTKOWA MOŻLIWOŚĆ  
PERSONALIZACJI  
W DOWOLNYM KOLORZE**

A UNIQUE POSSIBILITY  
OF PERSONALISATION  
IN ANY COLOR

DRUK SUBLIMACYJNY / SUBLIMATION PRINTING



**rPET**

rok / year design

drukowany / printed

kolor / colour

biały / white



**rPET** jest materiałem **RECYKLINGOWYM** pozyskiwanym w 100% z odpadów pokonsumpcyjnych, najczęściej z butelek typu PET. Na 1 m<sup>2</sup> wykorzystuje się 12 butelek 1,5 litrowych. Materiał recyklingowy przeznaczony do druku sublimacyjnego – wg CMYK.

**rPET** is a **RECYCLING** material obtained in 100% from post-consumer waste, most often from PET bottles. 12 bottles of 1.5 liters are used per 1 m<sup>2</sup>. Recycling material intended for sublimation printing – CMYK.

DEDYKOWANE ZNAKOWANIE OPRAW, UKŁADY KALENDARZY I NOTESÓW ZAMIESZCZONE SĄ OD STRONY 77. / DEDICATED MARKING METHODS OF COVERS, LAYOUTS OF CALENDARS AND NOTEBOOKS ARE AVAILABLE FROM PAGE 77.

**rPET**  
**DRUK**  
**SUBLIMACYJNY**  
SUBLIMATION  
PRINTING

**rPET**

WYBIERZ SWÓJ KALENDARZ LUB NOTES  
Z BLOKIEM PAPIERU Z RECYKLINGU (~A5, ~B5),  
ABY CIESZYĆ SIĘ 100% EKOLOGICZNYM  
PRODUKTEM Z ODZYSKANYCH SUROWCÓW.

CHOOSE YOUR CALENDAR OR NOTEBOOK  
WITH A BLOCK OF RECYCLED PAPER (~A5, ~B5),  
TO ENJOY A 100% ECOLOGICAL PRODUCT  
MADE OF RECYCLED RAW MATERIALS.



**INSPIRACJA / INSPIRATION**

**rok / year design**

**oprawa / cover**

**znakowanie / marking method**

**drukowany / printed**

**rPET**

**druk sublimacyjny / sublimation printing**

## RE-COVER



### INSPIRACJA / INSPIRATION

rok / year design

drukowany / printed

oprawa / cover

RE-COVER

znakowanie / marking method

druk / print

DEDYKOWANE ZNAKOWANIE OPRAW, UKŁADY KALENDARZY I NOTESÓW ZAMIESZCZONE SĄ OD STRONY 77. / DEDICATED MARKING METHODS OF COVERS, LAYOUTS OF CALENDARS AND NOTEBOOKS ARE AVAILABLE FROM PAGE 77.





## RE-COVER

rok / year design

drukowany / printed

kolor / colour

beżowy / beige

grafitowy / graphite **NEW**

ceglany / brick **NEW**

Oprawa **RE-COVER** jest surowcem pozyskiwanym w procesie **recyklingu** ze skór naturalnych. Jest w pełni zgodna z rozporządzeniem REACH oraz konwencją waszyngtońską CITES. Parametry wytrzymałości są określone metodą EN ISO 3376:2011.

New cover called **RE-COVER** is a raw material obtained in the process of **recycling** natural leather. They are fully compliant with the REACH regulation and the Washington CITES Convention. The strength parameters are determined by the EN ISO 3376:2011 method.



## INSPIRACJA / INSPIRATION

rok / year design

oprawa / cover

znakowanie / marking method

drukowany / printed

RE-COVER

druk / print

# QUERK



## QUERK

rok / year design

drukowany / printed

kolor / colour

beżowy / beige

**Korek** to naturalny materiał pozyskiwany z kory dębu korkowego. Jest materiałem w pełni ekologicznym, a dodatkowo wegańskim. Nie ma dwóch takich samych fragmentów, co stanowi o wyjątkowości tego materiału.

**Cork** is a natural material obtained from the bark of the Quercus Suber. It is a fully ecological material and, additionally, vegan. There are no two identical pieces, which makes this material unique.

## INSPIRACJA / INSPIRATION

rok / year design

drukowany / printed

oprawa / cover

QUERK

znakowanie / marking method

druk / print

DEDYKOWANE ZNAKOWANIE OPRAW, UKŁADY KALENDARZY I NOTESÓW ZAMIESZCZONE SĄ OD STRONY 77. / DEDICATED MARKING METHODS OF COVERS, LAYOUTS OF CALENDARS AND NOTEBOOKS ARE AVAILABLE FROM PAGE 77.

# DBAJ O EKOLOGIE

TAKE CARE  
OF THE  
ENVIRONMENT



2

3

## INSPIRACJA / INSPIRATION

rok / year design

oprawa / cover

znakowanie / marking method

dodatek / add-on

drukowany / printed

QUERK

druk / print

2 – gumka grzbietowa / spine elastic, G0072 **NEW** – długopis / pen, 3 – M16

# NATURA



## NATURA

rok / year design

18

kolor / colour

beżowy / beige

granatowy / dark blue

grafitowy / graphite

szary / grey **NEW**



OPRAWA **NATURA** Z CERTYFIKATEM FSC, KTÓRA DBA O LASY I PRZYSZŁOŚĆ NASZEJ PLANETY.

**NATURA** COVER WITH THE FSC CERTIFICATE, WHICH CARES FOR FORESTS AND THE FUTURE OF OUR PLANET.

DEDYKOWANE ZNAKOWANIE OPRAW, UKŁADY KALENDARZY I NOTESÓW ZAMIESZCZONE SĄ OD STRONY 77. / DEDICATED MARKING METHODS OF COVERS, LAYOUTS OF CALENDARS AND NOTEBOOKS ARE AVAILABLE FROM PAGE 77.

**DRUK  
PATTERN  
W JEDNYM  
KOLORZE**

ONE COLOUR  
PATTERN  
PRINTING



1

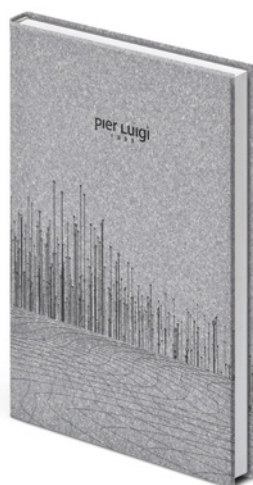

2



3



4

**INSPIRACJA / INSPIRATION**

rok / year design

oprawa / cover

znakowanie / marking method

drukowany na grzbiecie oprawy / printed on the spine of the cover

**NATURA**

druk / print

# SAVANA

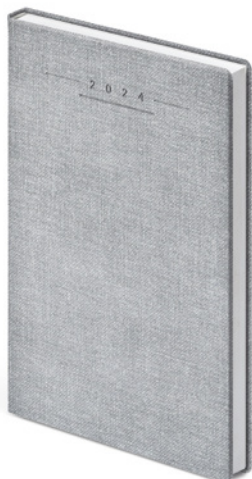
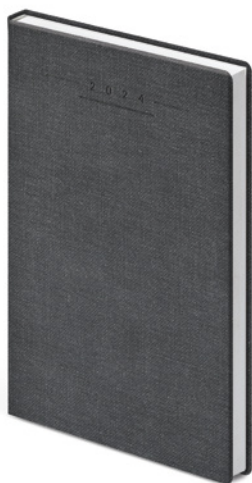
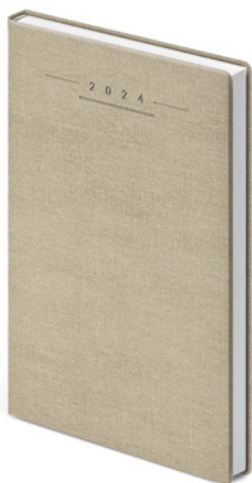

## SAVANA

rok / year design

22

kolor / colour

beżowy / beige

grafitowy / graphite

szary / grey

granatowy / dark blue



100% EKOLOGICZNA OPRAWA **SAVANA** – POCHODZĄCA Z LASÓW ZARZĄDZANYCH ZGODNIE Z ZASADAMI ZRÓWNOWAŻONEGO ROZWOJU.

100% ECOLOGICAL **SAVANA** COVER – COMING FROM FORESTS MANAGED IN ACCORDANCE WITH THE PRINCIPLES OF SUSTAINABLE DEVELOPMENT.

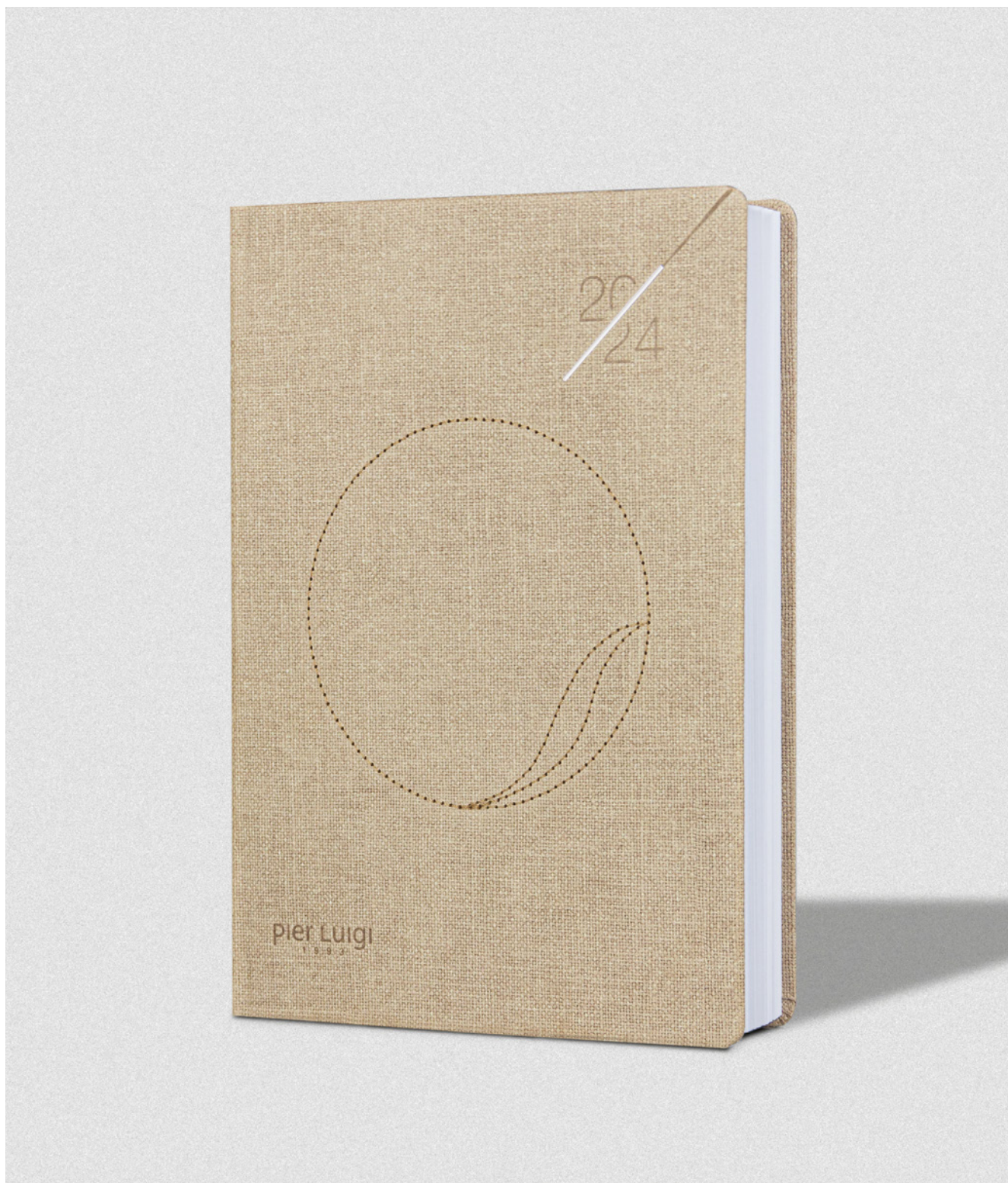

**INSPIRACJA / INSPIRATION**

**rok / year design**

**16B**

**oprawa / cover**

**SAVANA**

**znakowanie / marking method**

**łóczenie, szycie kreatywne / debossing, creative stitching**

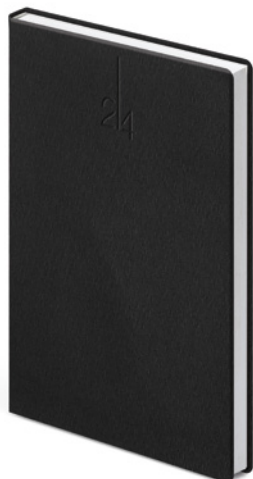
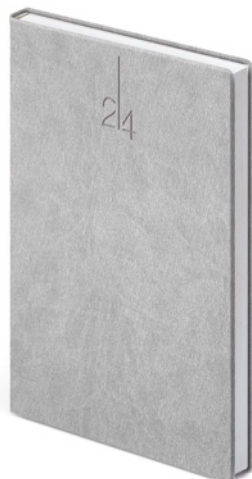

## GAMBO

---

rok / year design

---

20

---

kolor / colour

---

zielony / green **NEW**  
brązowy / brown **NEW**  
szary / grey **NEW**  
czarny / black **NEW**

---

## **B1** OKRĄG BAMBUSOWY / BAMBOO CIRCLE

---

MOŻLIWOŚĆ ZNAKOWANIA KALENDARZA ELEMENTEM Z BAMBUSU O STRUKTURZE **3D** NADAJE PRODUKTOWI NIEPOWTARZALNY CHARAKTER.

THE POSSIBILITY OF MARKING THE CALENDAR WITH A BAMBOO ELEMENT WITH A **3D** STRUCTURE GIVES THE PRODUCT A UNIQUE CHARACTER.

---



**B1** NEW

**DODAJ  
BAMBUSOWY  
ELEMENT**

ADD A BAMBOO  
ELEMENT



INSPIRACJA / INSPIRATION

rok / year design

oprawa / cover

znakowanie / marking method

dodatek / add-on

**B1** NEW

**GAMBO**

**1** – tłoczenie, przeszycie w pionie / debossing, vertical stitching

**2** – tłoczenie wielkoformatowe / large format debossing

**1** – szlufka na długopis / elastic pen holder, **G0073** NEW – długopis / pen

## COLORADO **NEW**

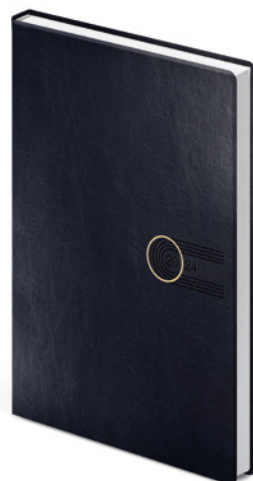
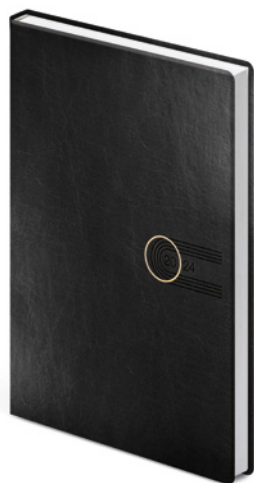
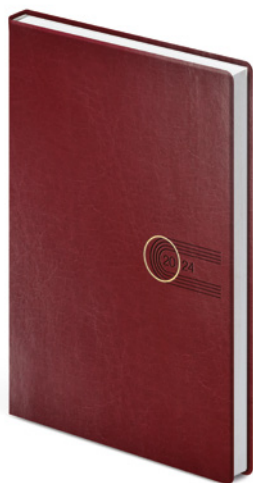

### COLORADO

rok / year design

---

19A

---

kolor / colour

---

bordowy / maroon **NEW**

czarny / black **NEW**

granatowy / dark blue **NEW**

czekoladowy / chocolate **NEW**

---



DEDYKOWANE ZNAKOWANIE OPRAW, UKŁADY KALENDARZY I NOTESÓW ZAMIESZCZONE SĄ OD STRONY 77. / DEDICATED MARKING METHODS OF COVERS, LAYOUTS OF CALENDARS AND NOTEBOOKS ARE AVAILABLE FROM PAGE 77.



**INSPIRACJA / INSPIRATION**

**rok / year design**

**4A**

**oprawa / cover**

**COLORADO**

**znakowanie / marking method**

**łtczenie, szycie kreatywne / debossing, creative stitching**

## CROSS

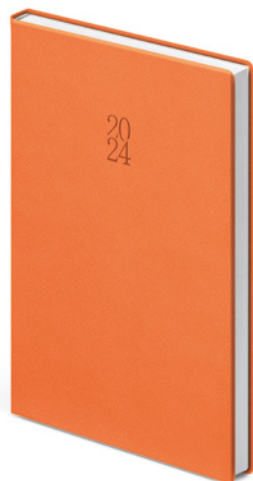
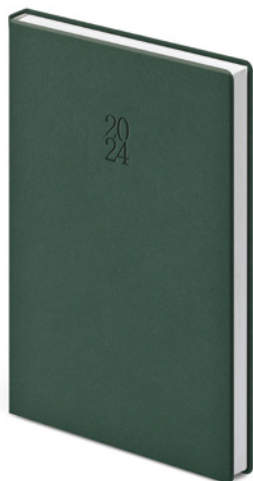
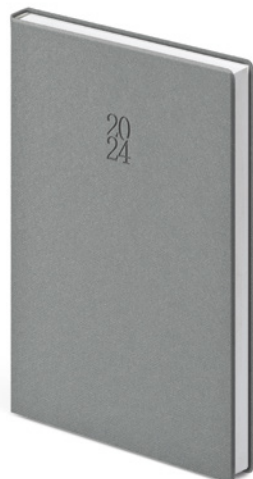
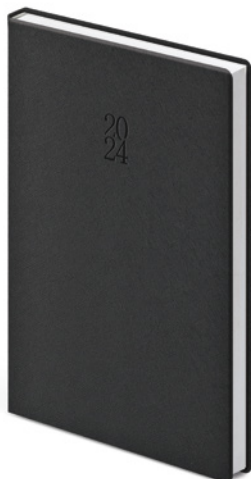
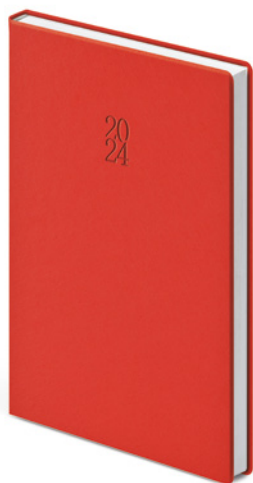

### CROSS

---

rok / year design

---

6

---

kolor / colour

---

**czerwony** / red  
**granatowy** / dark blue  
**czarny** / black  
**szary** / grey  
**zielony** / green  
**pomarańczowy** / orange **NEW**

---

DEDYKOWANE ZNAKOWANIE OPRAW, UKŁADY KALENDARZY I NOTESÓW ZAMIESZCZONE SĄ OD STRONY 77. / DEDICATED MARKING METHODS OF COVERS, LAYOUTS OF CALENDARS AND NOTEBOOKS ARE AVAILABLE FROM PAGE 77.

**M16**  
**ZASUWKA**  
**METALOWA**  
METAL HASP



**INSPIRACJA / INSPIRATION**

**rok / year design** 7

**oprawa / cover** CROSS

**znakowanie / marking method** grawer, przeszycie w pionie / engraving, vertical stitching

**dodatek / add-on** M16 + koperta / M16 + envelope\*

\*M16 NIEDOSTĘPNA DLA FORMATU 504T I BLOKÓW Z PAPIERU Z TRAWY. / M16 NOT AVAILABLE FOR 504T OR GRASS PAPER BLOCKS.

# PIKO

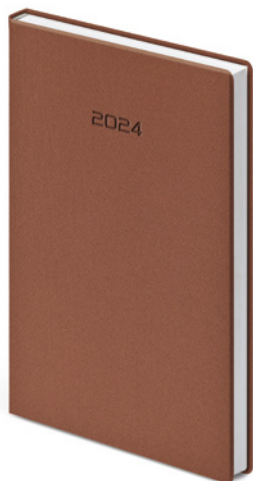
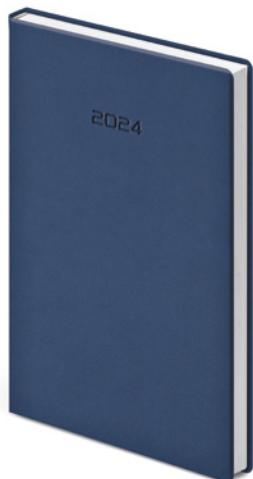

## PIKO

---

rok / year design

---

2B

---

kolor / colour

---

szary / grey

czarny / black

granatowy mat / dark blue matte

granatowy błysk / dark blue shiny

---

brązowy / brown

DEDYKOWANE ZNAKOWANIE OPRAW, UKŁADY KALENDARZY I NOTESÓW ZAMIESZCZONE SĄ OD STRONY 77. / DEDICATED MARKING METHODS OF COVERS, LAYOUTS OF CALENDARS AND NOTEBOOKS ARE AVAILABLE FROM PAGE 77.



#### INSPIRACJA / INSPIRATION

rok / year design

**1** – M4, **2** – 17A

oprawa / cover

**PIKO**

znakowanie / marking method

**2** – **tłoczenie** / debossing

dodatek / add-on

**1** – **gumka pionowa płaska 10 mm** / 10 mm flat elastic band

## METALLIC PRINT



### INSPIRACJA / INSPIRATION

wymiar / size

oprawa / cover\*

uszlachetnienie oprawy / cover finishing

wykończenie / finishing

nakład / print run

pod każdy format / for any format

papier / paper

folia: soft touch / foil: soft touch

**METALLIC PRINT** – złoty, srebrny, hologramowy /  
gold, silver, hologram

min. 200 szt. / MOQ 200 pcs.

\*NAROŻNIKI OKŁADKI PAPIEROWEJ, TYLKO PROSTE ROGI NA TEKSTURZE TWARDEJ. / PAPER COVER CORNERS, ONLY STRAIGHT CORNERS.



**ZWYKŁA FOLIA  
TO JUŻ ZA MAŁO**

STANDARD FOIL  
IS NOT ENOUGH  
ANYMORE



4



# GUMA

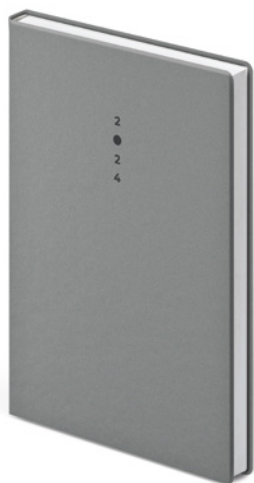
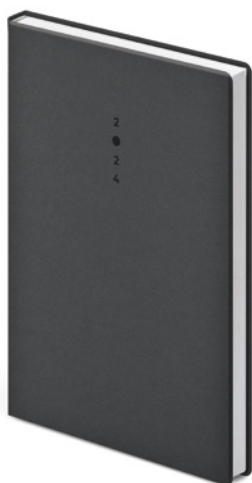

Druk UV / UV PRINT

## GUMA

rok / year design

---

10

---

kolor / colour

---

czarny / black

szary / grey

granatowy / dark blue

czerwony / red

biały / white

---

DEDYKOWANE ZNAKOWANIE OPRAW, UKŁADY KALENDARZY I NOTESÓW ZAMIESZCZONE SĄ OD STRONY 77. / DEDICATED MARKING METHODS OF COVERS, LAYOUTS OF CALENDARS AND NOTEBOOKS ARE AVAILABLE FROM PAGE 77.

**NAJWYŻSZA  
JAKOŚĆ DRUKU  
W PEŁNYM  
KOLORZE**

HIGHEST  
QUALITY PRINTING  
IN FULL COLOUR



**INSPIRACJA / INSPIRATION**

**rok / year design**

**oprawa / cover**

**znakowanie / marking method**

**drukowany / printed**

**GUMA**

**druk UV / UV PRINT**

# VIVELA

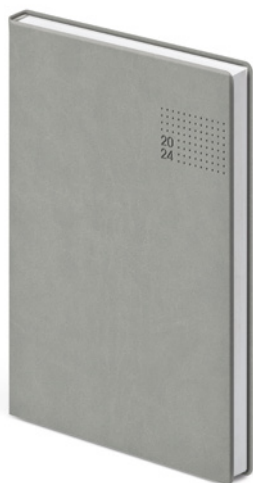

## VIVELA

rok / year design

---

14

---

kolor / colour

---

czarny / black

szary / grey

niebieski / blue **NEW**

granatowy / dark blue

zielony / green

turkusowy / turquoise

czerwony / red

magenta / magenta

pomarańczowy / orange

żółty / yellow

beżowy / beige **NEW**

---

DEDYKOWANE ZNAKOWANIE OPRAW, UKŁADY KALENDARZY I NOTESÓW ZAMIESZCZONE SĄ OD STRONY 77. / DEDICATED MARKING METHODS OF COVERS, LAYOUTS OF CALENDARS AND NOTEBOOKS ARE AVAILABLE FROM PAGE 77.

**M15**  
**METAL**  
**W TRENDACH**

METAL  
IN TRENDS



**INSPIRACJA / INSPIRATION**

rok / year design

12

oprawa / cover

VIVELA

znakowanie / marking method

grawer / engraving

dodatek / add-on

gumka pionowa płaska 10 mm + M15 / 10 mm vertical elastic band + M15



# CANVAS

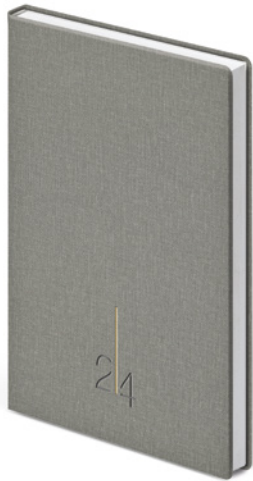
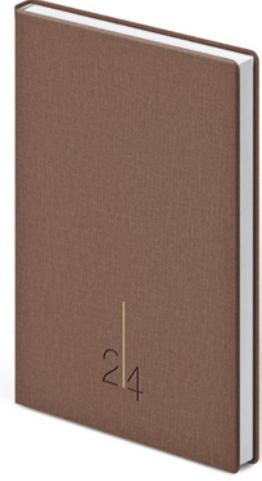
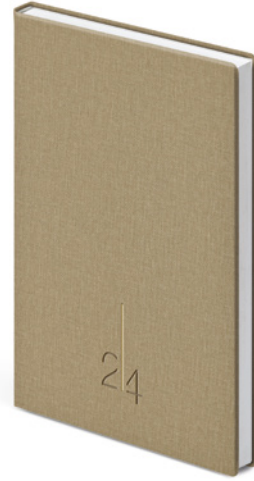
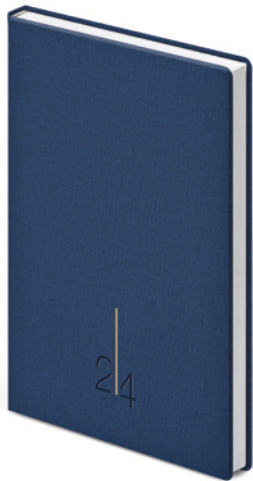
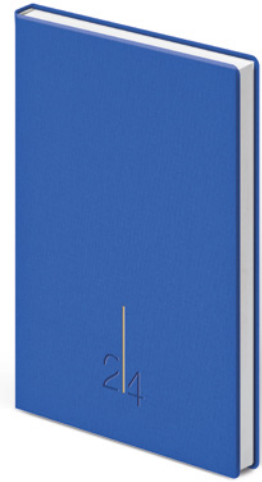
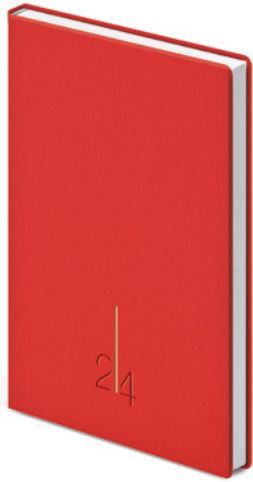

**DRUK UV / UV PRINT**



DEDYKOWANE ZNAKOWANIE OPRAW, UKŁADY KALENDARZY I NOTESÓW ZAMIESZCZONE SĄ OD STRONY 77. / DEDICATED MARKING METHODS OF COVERS, LAYOUTS OF CALENDARS AND NOTEBOOKS ARE AVAILABLE FROM PAGE 77.

## SZYCIE KREATYWNE

CREATIVE  
STITCHING



1

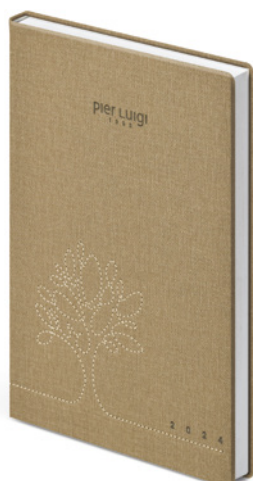

2

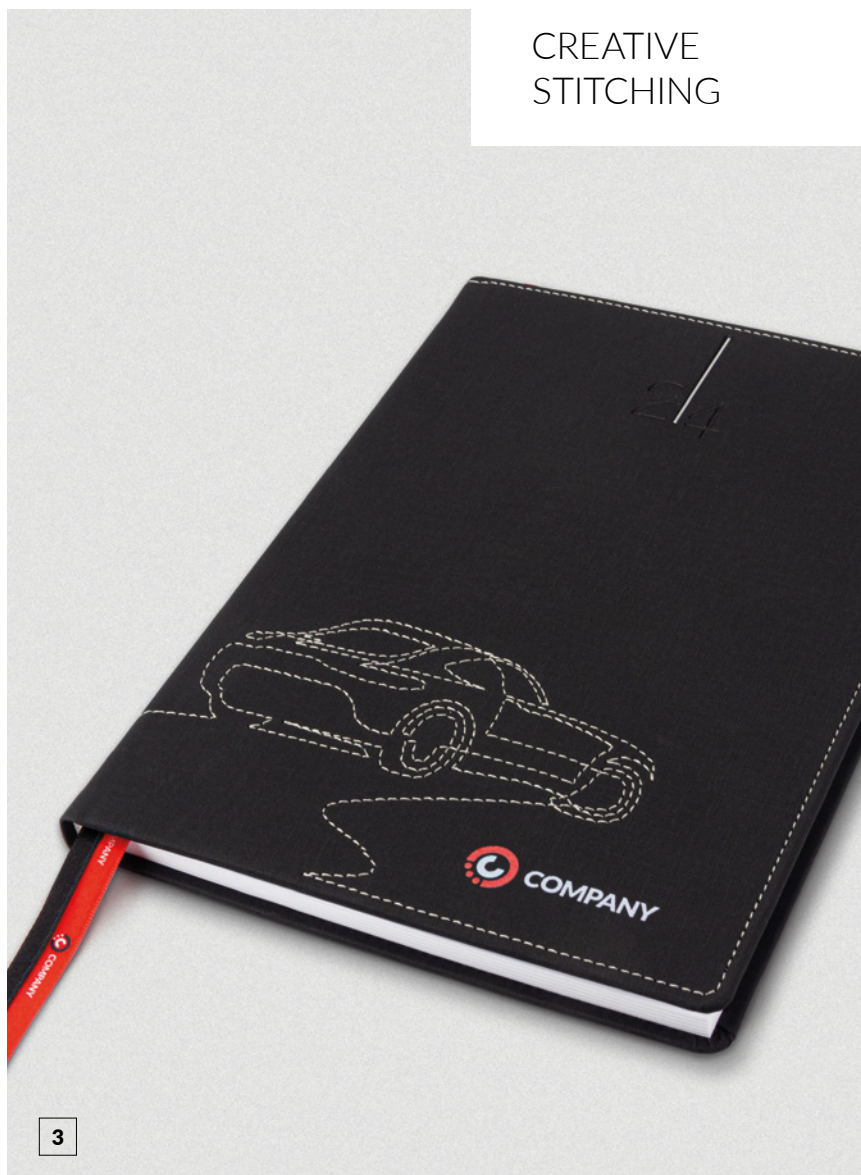

3

MOŻLIWOŚĆ WYKORZYSTANIA PREZENTOWANYCH WZORÓW  
LUB WYSZYCIA OPRAWY WG AUTORSKIEGO PROJEKTU. /  
POSSIBILITY TO USE THE PRESENTED PATTERNS OR EMBROIDER  
THE FRAME ACCORDING TO A CUSTOMISED DESIGN.

### ◀ CANVAS

rok / year design

20A

kolor / colour

czerwony / red  
zielony / green  
niebieski / blue  
granatowy / dark blue  
beżowy / beige  
brązowy / brown  
szary / grey  
czarny / black  
biały / white

### INSPIRACJA / INSPIRATION

rok / year design

oprawa / cover

znakowanie /  
marking method

projekt / design

dodatek / add-on

1 2 – drukowany / printed, 3 – 20B

### CANVAS

1 – druk, szycie kreatywne / print, creative stitching

2 – tłoczenie, szycie kreatywne /  
debossing, creative stitching

3 – druk, tłoczenie, szycie kreatywne /  
print, debossing, creative stitching

kolor oprawy i nici do wyboru / cover colours and  
sewing threads to choose

3 – tasiemka sublimacyjna / sublimation ribbon

## CANVAS LINE

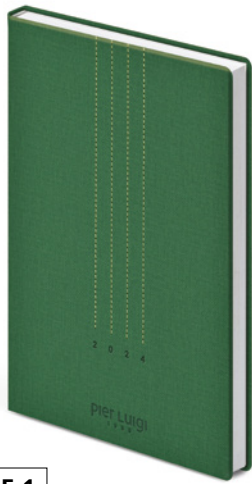

LINE 1



LINE 2

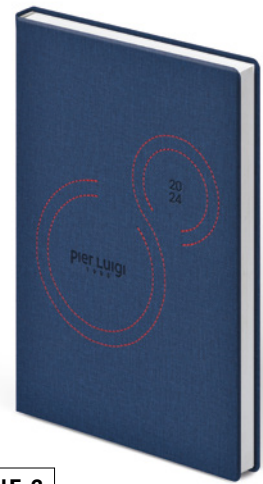

LINE 3



### INSPIRACJA / INSPIRATION

rok / year design

LINE 1 LINE 2 – 12, LINE 3 – 7, LINE 4 – 9, LINE 5 – 16A, LINE 6 – 21A

oprawa / cover

CANVAS

znakowanie / marking method

łóczenie, szycie kreatywne / debossing, creative stitching

projekt / design

kolor oprawy i nici do wyboru / cover colours and sewing threads to choose

DEDYKOWANE ZNAKOWANIE OPRAW, UKŁADY KALENDARZY I NOTESÓW ZAMIESZCZONE SĄ OD STRONY 77. / DEDICATED MARKING METHODS OF COVERS, LAYOUTS OF CALENDARS AND NOTEBOOKS ARE AVAILABLE FROM PAGE 77.



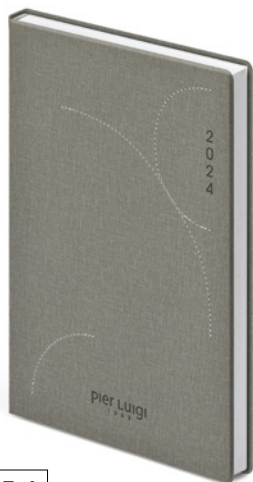

LINE 4



LINE 5 NEW

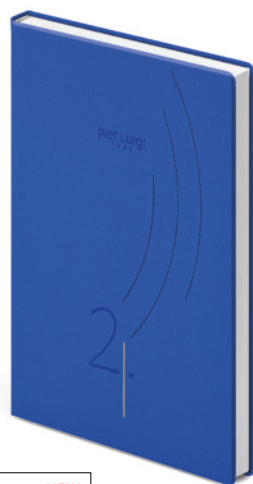

LINE 6 NEW



## CANVAS - SPINE / HORIZONT

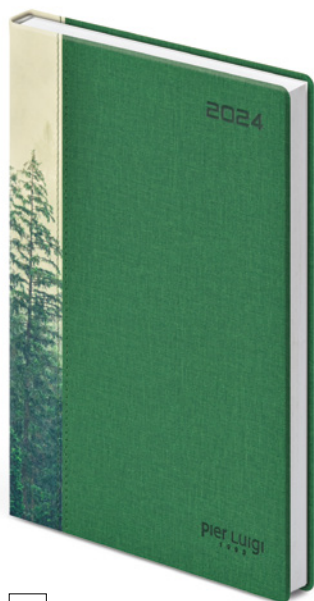

1



2

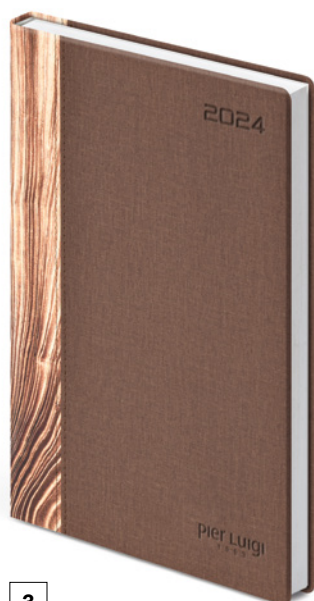

3



4

## CANVAS - SPINE / HORIZONT

rok / year design

2B

oprawa / cover

CANVAS + CANVAS

łączenie opraw / cover combinations\*

1 3 5 - 10 SPINE, 2 4 - 28 HORIZONT

znakowanie / marking method

druk UV, tłoczenie / UV print, debossing

projekt / design

kolor oprawy i nici do wyboru / cover colours and sewing threads to choose

\*ŁĄCZENIE OPRAW CANVAS - SPINE / HORIZONT TYLKO NA TEKSTURZE TWARDEJ. / CONNECTING THE CANVAS COVER MATERIAL - SPINE / HORIZONT ONLY ON HARD CARDBOARD.

**TWOJA MARKA  
W KOLORZE**

YOUR BRAND  
IN COLOUR



2



5

## KRAFT



### KRAFT

---

rok / year design

---

M4

---

kolor / colour

---

granatowy / dark blue

grafitowy / graphite

---



### INSPIRACJA / INSPIRATION

rok / year design

10B

oprawa / cover

KRAFT

znakowanie / marking method

łtczenie, szycie kreatywne / debossing, creative stitching

dodatek / add-on

M17B

projekt / design

kolor oprawy i nici do wyboru / cover colours and sewing threads to choose

DEDYKOWANE ZNAKOWANIE OPRAW, UKŁADY KALENDARZY I NOTESÓW ZAMIESZCZONE SĄ OD STRONY 77. / DEDICATED MARKING METHODS OF COVERS, LAYOUTS OF CALENDARS AND NOTEBOOKS ARE AVAILABLE FROM PAGE 77.

## DURO



### DURO

---

rok / year design

---

3

---

kolor / colour

---

szary / grey  
czarny / black

---



### DURO DUO - INSPIRACJA / INSPIRATION

rok / year design

M3

oprawa / cover

DURO + GUMA

łączenie opraw / cover combinations\*

11

znakowanie / marking method

tłoczenie / debossing

dodatek / add-on

finochrom autorski / customised finochrome

DEDYKOWANE ZNAKOWANIE OPRAW, UKŁADY KALENDARZY I NOTESÓW ZAMIESZCZONE SĄ OD STRONY 77. / DEDICATED MARKING METHODS OF COVERS, LAYOUTS OF CALENDARS AND NOTEBOOKS ARE AVAILABLE FROM PAGE 77.

\*WYBÓR DOSTĘPNYCH ŁĄCZEŃ OPRAW NA STRONIE 83. / SELECTION OF AVAILABLE TEMPLATES CONNECTIONS FOR COVERS ON THE PAGE 83.

## IMAGE

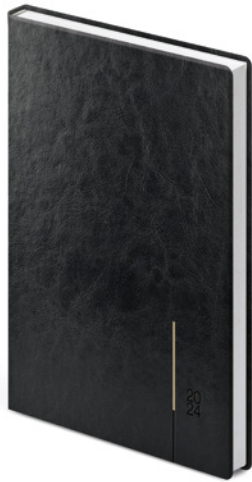

### IMAGE

rok / year design

---

17A

---

kolor / colour

---

czarny / black

granatowy / dark blue

graftowy / graphite **NEW**

---

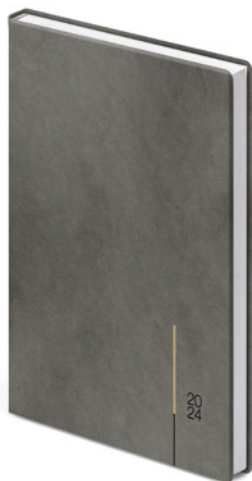
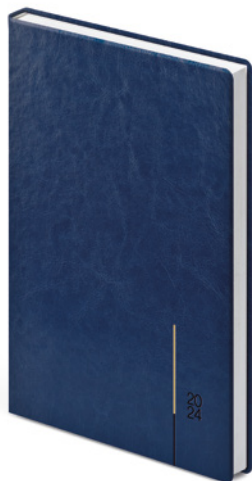

### INSPIRACJA / INSPIRATION

rok / year design

7

oprawa / cover

IMAGE

znakowanie / marking method

grawer / engraving

dodatek / design\*

M8 - 32 GB

\*Z WYKLUCZENIEM FORMATU 504T. / DOES NOT APPLY TO BLOCK 504T.

## FLESZ



### FLESZ

rok / year design

21

kolor / colour

srebrny / silver

złoty / gold

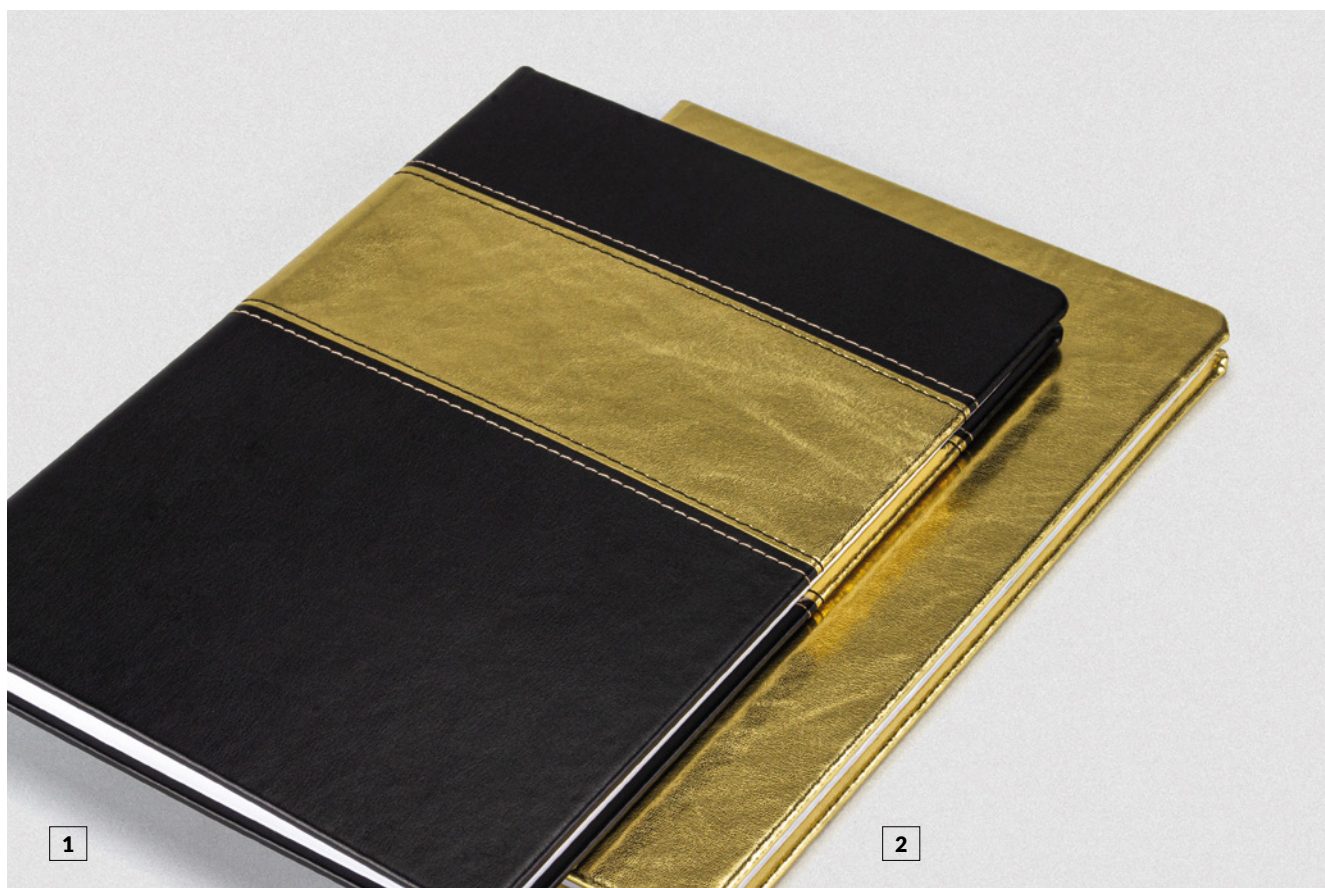

### INSPIRACJA / INSPIRATION

rok / year design

9 – na grzbiecie oprawy / on the spine of the cover

oprawa / cover

1 – IDEO + FLESZ, 2 – FLESZ

łączenie opraw / cover combinations\*

1 – 29

projekt / design

1 – kolor oprawy i nici do wyboru / cover colours and sewing threads to choose

DEDYKOWANE ZNAKOWANIE OPRAW, UKŁADY KALENDARZY I NOTESÓW ZAMIESZCZONE SĄ OD STRONY 77. / DEDICATED MARKING METHODS OF COVERS, LAYOUTS OF CALENDARS AND NOTEBOOKS ARE AVAILABLE FROM PAGE 77.

\*WYBÓR DOSTĘPNYCH ŁĄCZEŃ OPRAW NA STRONIE 83. / SELECTION OF AVAILABLE TEMPLATES CONNECTIONS FOR COVERS ON THE PAGE 83.

## IDEO

Druk UV / UV PRINT



## IDEO

rok / year design

---

16A

---

kolor / colour

---

biały / white

seledynowy / willow-green

czerwony / red

granatowy / dark blue

czarny / black

szary / grey

jasny brąz / light brown **NEW**

bordowy / maroon **NEW**

---

DEDYKOWANE ZNAKOWANIE OPRAW, UKŁADY KALENDARZY I NOTESÓW ZAMIESZCZONE SĄ OD STRONY 77. / DEDICATED MARKING METHODS OF COVERS, LAYOUTS OF CALENDARS AND NOTEBOOKS ARE AVAILABLE FROM PAGE 77.



**PODKREŚL  
SWÓJ STYL**

EXPRESS  
YOUR STYLE



INSPIRACJA / INSPIRATION

rok / year design

1 - 20A, 2 - 23A

oprawa / cover

IDEO

znakowanie / marking method

tłoczenie / debossing

IDEO EXCLUSIVE



CHEVRON



HILLS



CARO



VENUS



SQUARES



CRYSTALS **NEW**

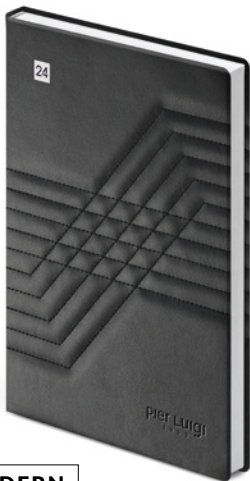

MODERN



VICTORY



DUNES **NEW**



**OVAL** NEW



**CHART** NEW



## IDEO EXCLUSIVE

rok / year design

oprawa / cover

znakowanie / marking method

projekt / design

M4

IDEO

łtłczenie, szycie kreatywne / debossing, creative stitching

kolor oprawy i nici do wyboru / cover colours and sewing threads to choose

## ZESTAWY PREMIUM / PREMIUM SETS



### PREMIUM CARO

**kalendarz z papieru z kamienia /**  
stone paper calendar

511T / 512T / 516 / 509T

**rok / year design**

M4

**oprawa / cover**

IDEO

**znakowanie / marking method**

**szycie kreatywne, 6 kryształów Swarovskiego / creative stitching, 6 Swarovski crystals**

**opakowanie / packaging**

**czarny papier barwiony w masie z przetłoczeniem, kalka z logo firmy /**  
black mass dyed paper with debossing, tracing paper with company logo

**inne / other**

**wyklejka z papieru barwionego w masie / mass dyed endpaper**



## PREMIUM LOCK

kalendarz z papieru z kamienia /  
stone paper calendar

rok / year design

oprawa / cover

znakowanie / marking method

dodatek / add-on

opakowanie / packaging

inne / other

511T / 512T / 516 / 509T

9 – na grzbiecie oprawy / on the spine of the cover

IDEO

grawer, obszycie / engraving, stitching

M11

czarny papier barwiony w masie z przetłoczeniem w kolorze srebrnym, kalka z logo firmy / black mass dyed paper with silver debossing, tracing paper with company logo

wyklejka z czarnego papieru barwionego w masie z tłoczonym logo na srebrno – wspólna matryca z opakowaniem / silver debossed logo on the both: the black mass dyed endpaper and the packaging

# CARBON



## CARBON

rok / year design

M3

kolor / colour

granatowy / dark blue

czarny / black

szary / grey



1

2

3

## PRESTO - INSPIRACJA / INSPIRATION

rok / year design

1 4 - M2, 2 5 - 9 - na grzbiecie oprawy / on the spine of the cover, 3 - M3

oprawa / cover

CARBON + VIVELA

łączenie opraw / cover combinations\* 21

znakowanie / marking method

1 2 4 5 - grawer / engraving

DEDYKOWANE ZNAKOWANIE OPRAW, UKŁADY KALENDARZY I NOTESÓW ZAMIESZCZONE SĄ OD STRONY 77. / DEDICATED MARKING METHODS OF COVERS, LAYOUTS OF CALENDARS AND NOTEBOOKS ARE AVAILABLE FROM PAGE 77.

\*WYBÓR DOSTĘPNYCH ŁĄCZEŃ OPRAW NA STRONIE 83. / SELECTION OF AVAILABLE TEMPLATES CONNECTIONS FOR COVERS ON THE PAGE 83.

**M1/M2**  
**METALOWY**  
**ELEMENT**  
**MOŻE**  
**TAK WIELE...**

METAL  
ELEMENT  
HAS SO MUCH  
POTENTIAL...



4

5

## ITALIANO



### ITALIANO

---

rok / year design

---

18

---

kolor / colour\*

---

granatowy / dark blue

brązowy / brown

czarny / black

---



\*ZRÓŻNICOWANY KOLOR SKÓRY I WYSTĘPUJĄCE NA NIEJ ZAGIĘCIA SĄ JEJ NATURALNYMI ELEMENTAMI I STANOWIĄ O JEJ WYJĄTKOWYM WYGLĄDZIE. TE ELEMENTY NIE PODLEGAJĄ REKLAMACJI. / THE VARIED COLOUR OF THE SKIN AND THE FOLDS ON IT ARE ITS NATURAL ELEMENTS AND DETERMINE ITS UNIQUE APPEARANCE. THESE ELEMENTS ARE NOT SUBJECT TO COMPLAINT.



**SKÓRA NATURALNA  
NIEPRZEMIJAJĄCA  
KLASYKA**

NATURAL LEATHER  
THE LASTING  
CLASSIC



**INSPIRACJA / INSPIRATION**

**rok / year design** 18

**oprawa / cover** ITALIANO

**znakowanie / marking method** tłoczenie, obszycie / debossing, stitching

**dodatek / add-on** M20A

DEDYKOWANE ZNAKOWANIE OPRAW, UKŁADY KALENDARZY I NOTESÓW ZAMIESZCZONE SĄ OD STRONY 77. / DEDICATED MARKING METHODS OF COVERS, LAYOUTS OF CALENDARS AND NOTEBOOKS ARE AVAILABLE FROM PAGE 77.

## PATKI / SYNTHETIC LEATHER TABS

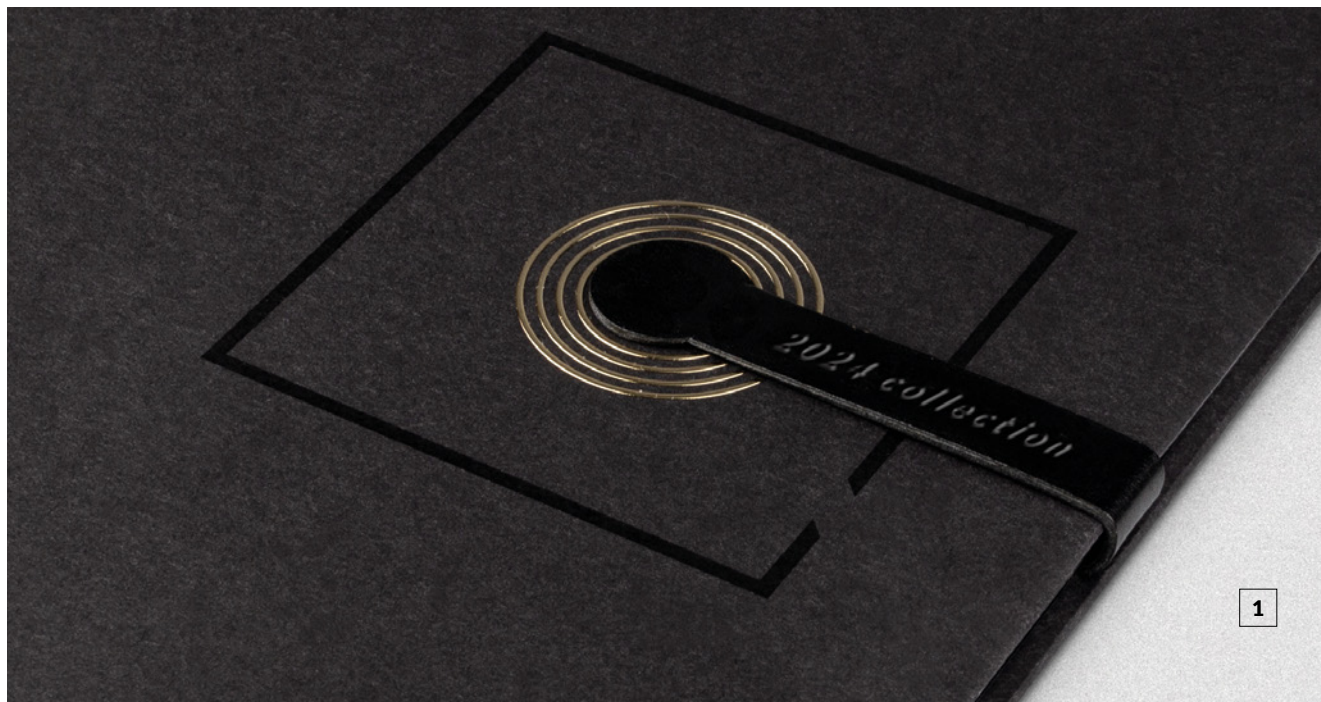

### INSPIRACJA / INSPIRATION

oprawa / cover\*

**1** – NATURA, **2** – IDEO

znakowanie / marking method

**1** – druk, tłoczenie folią, tłoczenie na patce /  
print, foil stamping, debossing on the synthetic leather tab

dodatek / add-on\*\*

**1** – patka MINI / MINI synthetic leather tab  
**2** – patka MAXI / MAXI synthetic leather tab

\*RODZAJ I KOLOR OPRAWY DO WYBORU. / TYPE AND COLOUR OF THE COVER MATERIAL ACCORDING TO YOUR CHOICE.

\*\* RODZAJ I KOLOR OPRAWY DO WYBORU Z WYKLUCZENIEM OPRAW PAPIEROWYCH I rPET. / TYPE AND COLOUR OF THE COVER MATERIAL ACCORDING TO YOUR CHOICE, EXCLUDING PAPER AND rPET COVERS.

**TWOJE  
NOTATKI  
BEZPIECZNIE  
ZAMKNIĘTE**

YOUR NOTES  
SAFELY LOCKED

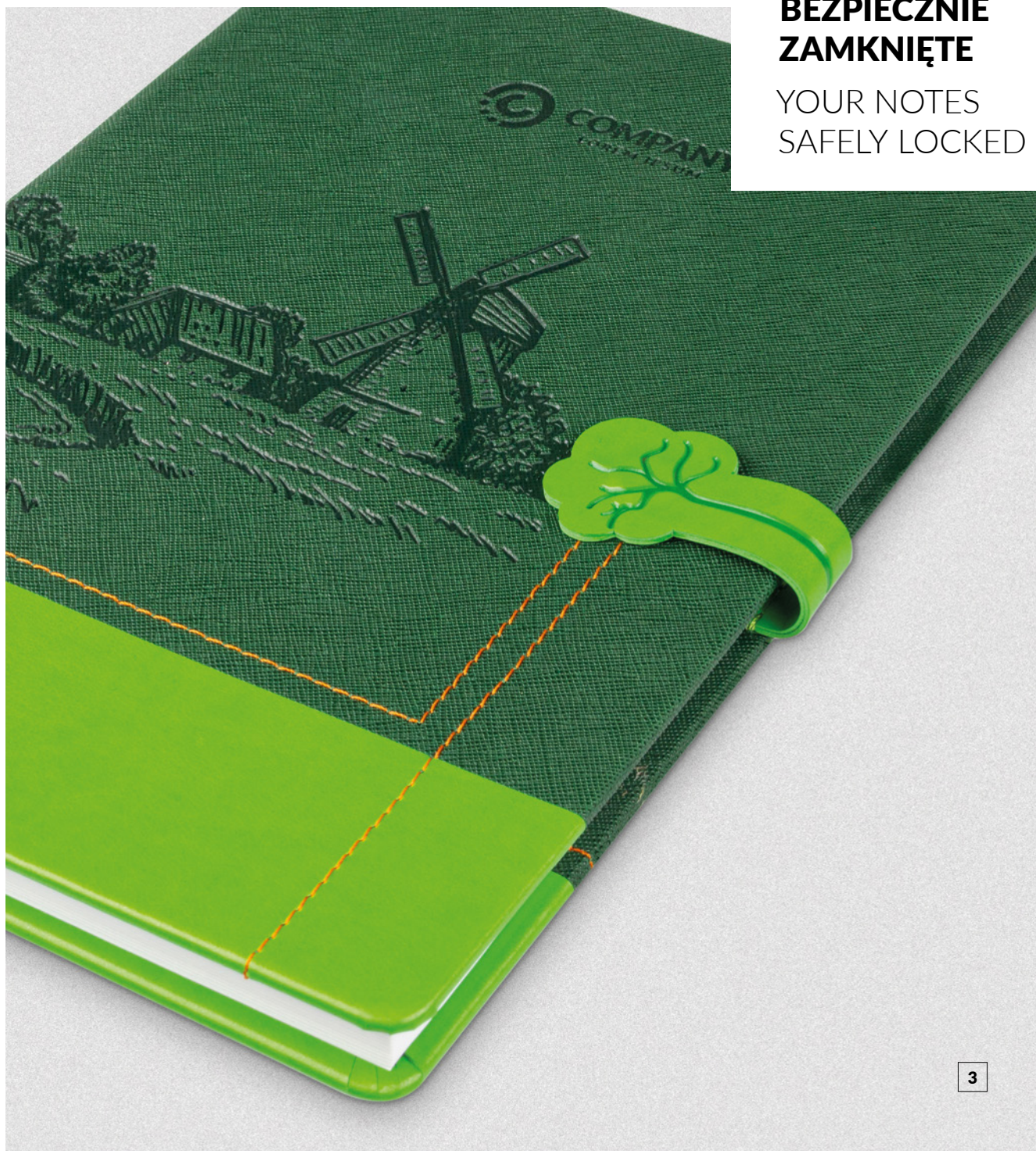

3

**INSPIRACJA / INSPIRATION**

**oprawa / cover\***

**VIVELA + CROSS**

**łączenie opraw / cover combinations\*\*\* 9**

**znakowanie / marking method**

**łtłczenie wielkoformatowe, łtłczenie na patce, szycie kreatywne /  
large format debossing, debossing on the synthetic leather tab, creative stitching**

**dodatek / add-on\*\***

**patka autorska / customised synthetic leather tab**

\*\*\*WYBÓR DOSTĘPNYCH ŁĄCZEŃ OPRAW NA STRONIE 83. / SELECTION OF AVAILABLE TEMPLATES CONNECTIONS FOR COVERS ON THE PAGE 83.

# KALENDARZ BIURKOWY STOJĄCY I LEŻĄCY / LYING AND STANDING DESK CALENDAR



1

LEŻĄCY / LYING

## INSPIRACJA / INSPIRATION

kalendarz / calendar

leżący / lying

rok / year design

2B

oprawa / cover\*

CANVAS

znakowanie / marking method

tłoczenie / debossing

DEDYKOWANE ZNAKOWANIE OPRAW, UKŁADY KALENDARZY I NOTESÓW ZAMIESZCZONE SĄ OD STRONY 77. / DEDICATED MARKING METHODS OF COVERS, LAYOUTS OF CALENDARS AND NOTEBOOKS ARE AVAILABLE FROM PAGE 77.

**PLAN  
TYGODNIA  
W ZASIĘGU  
WZROKU**

WEEKLY PLAN  
WITHIN VIEW



2

**STOJĄCY** / STANDING

**INSPIRACJA** / INSPIRATION

**kalendarz** / calendar

**stojący** / standing

**rok** / year design

**2B**

**oprawa** / cover\*

**VIVELA**

**znakowanie** / marking method

**tłoczenie** / debossing

\*RODZAJ I KOLOR OPRAWY DO WYBORU Z WYKLUCZENIEM rPET. / TYPE AND COLOUR OF THE COVER MATERIAL ACCORDING TO YOUR CHOICE, EXCLUDING rPET COVERS.

## OPAKOWANIA / PACKAGINGS



**PUDEŁKO KOPERTOWE / ENVELOPE BOX**

**PUDEŁKO WIECZKOWE / BOX WITH A LID**

**wymiar / size**

pod każdy format z wykluczeniem 504T, notes A6 /  
for any format except 504T, A6 notebook

**materiał / material**

papier barwiony w masie – czarny lub papier kraftowy /  
mass dyed paper – black or kraft paper

**znakowanie / marking method**

łoczenie folią, sitodruk / foil stamping, silk-screen

**ZRÓB  
PIERWSZE  
WRAŻENIE**

MAKE A FIRST  
IMPRESSION



**PUDEŁKO ZASUWANE / SLIDING BOX**

**wymiar / size** pod każdy format z wyłączeniem 504T, notes A6 /  
for any format except 504T, A6 notebook

**materiał / material\*** papier barwiony w masie lub papier kraftowy /  
mass dyed paper or kraft paper

**znakowanie / marking method** tłoczenie folią, sitodruk / foil stamping, silk-screen

\*DOSTĘPNE KOLORY NA STR. 75. / AVAILABLE COLORS ON PAGE 75.



## DODATKI / ADD-ONS

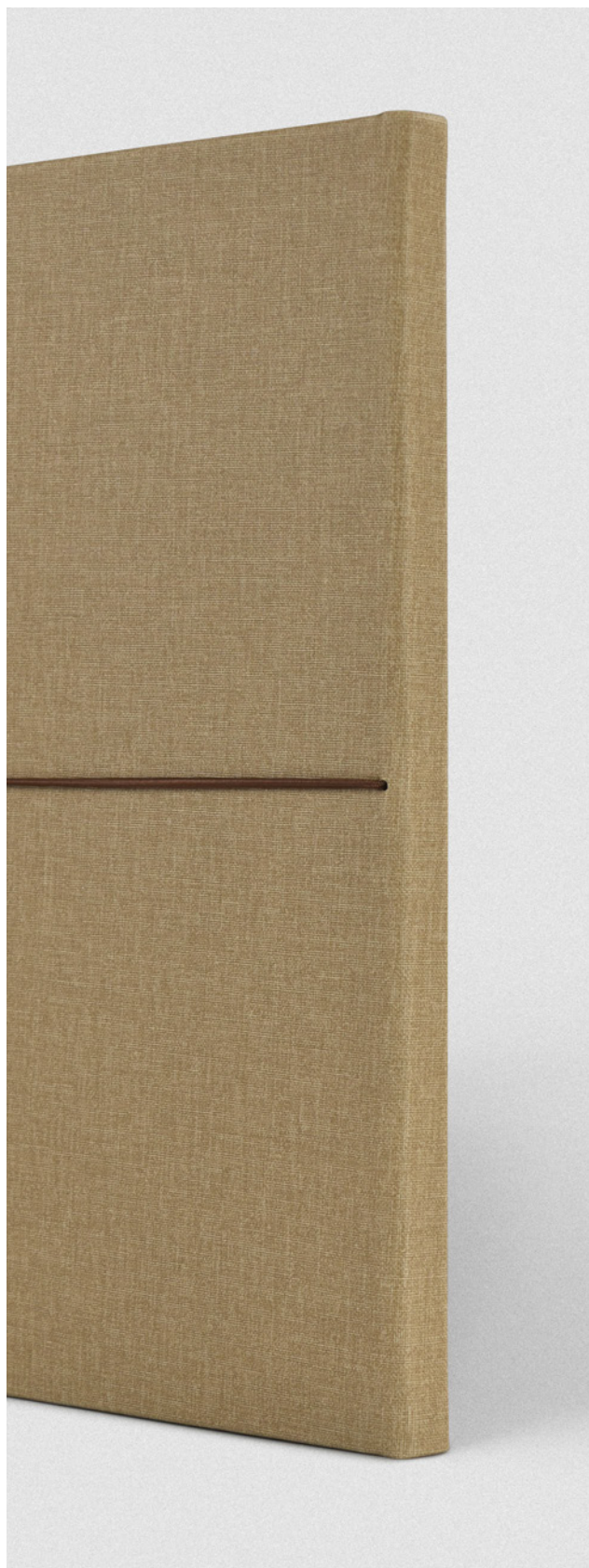

### GUMKA POZIOMA OKRĄGŁA 1,7 mm / 1,7 mm ROUND HORIZONTAL ELASTIC BAND\*

\*MONTAŻ GUMKI OKRĄGŁEJ NA GRZBIECIE TYLKO NA TWARDEJ OPRAWIE Z WYKLUCZENIEM OPRAW PAPIEROWYCH, QUERK I FORMATU 504T. / FITTING THE ROUND BAND ONLY ON A HARDCOVER EXCLUDING PAPER COVERS, QUERK AND 504T FORMAT.





GUMKA GRZBIETOWA  
Z MIEJSCEM NA DŁUGOPIS /  
SPINE ELASTIC PEN HOLDER



GUMKA POZIOMA PŁASKA 10 mm Z MIEJSCEM NA DŁUGOPIS /  
10 mm FLAT HORIZONTAL ELASTIC BAND WITH A LOOP

WZÓR UŻYTKOWY - URZĄD PATENTOWY RP. / UTILITY MODEL PATENT OFFICE OF THE REPUBLIC OF POLAND.

SZLUFKA NA DŁUGOPIS /  
ELASTIC PEN HOLDER



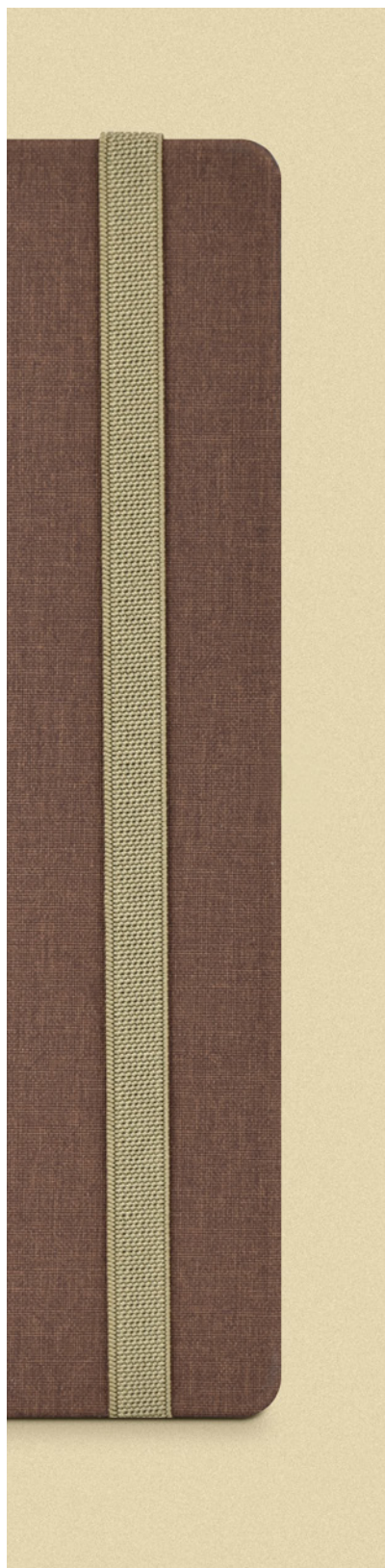



















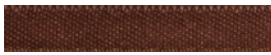



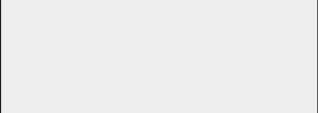















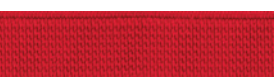

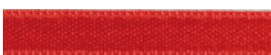
**GUMKA PIONOWA PŁASKA**  
10 mm / 10 mm FLAT  
VERTICAL ELASTIC BAND



**SPOSÓB MONTOWANIA GUMKI NA TYLE OKŁADKI.** /  
WAY OF ASSEMBLING THE ELASTIC BAND ON  
THE BACK COVER.

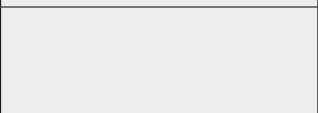

**GUMKA PIONOWA PŁASKA**  
10 mm + M15 /  
10 mm FLAT VERTICAL  
ELASTIC BAND + M15

GUMKA PŁASKA FLAT ELASTIC BAND 10 mm	GUMKA OKRĄGŁA ROUND ELASTIC BAND 1,7 mm	TASIEMKA RIBBON 6 mm	KOLOR COLOUR
			czarny / black
			szary / grey
			brązowy / brown
			granatowy ciemny / navy blue
			granatowy jasny / light navy blue
			niebieski / blue
			żółty / yellow
			zielony / green
			seledynowy / willow-green
			bordowy / maroon <b>NEW</b>
			czerwony / red
			pomarańczowy / orange
			magenta / magenta
			beżowy / beige

## DODATKI / ADD-ONS



### M1\*

BLASZKA ALUMINIOWA /  
ALUMINUM PLATE

wymiar / size

40 × 14 mm

pole graweru / engraving area

38 × 12 mm



### M2\*

BLASZKA ALUMINIOWA  
Z TŁOCZONYM ROKIEM /  
ALUMINUM PLATE WITH  
EMBOSSSED YEAR\*

wymiar / size

40 × 14 mm

pole graweru / engraving area

26 × 12 mm



### M3

ROK FINOCHROMOWY  
PRZYKLEJANY DO OPRAWY /  
FINOCHROME YEAR  
STICKED TO COVER

wymiar / size

41 × 8,5 mm



### M4

ROK FINOCHROMOWY  
PRZYKLEJANY DO OPRAWY /  
FINOCHROME YEAR  
STICKED TO COVER

wymiar / size

10 × 10 mm



### M8

PENDRIVE 32 GB  
MOCOWANY W OPRAWIE /  
32 GB FLASH DRIVE  
HOLDER IN THE COVER

wymiar / size

34 × 11 mm

pole graweru / engraving area

28 × 8 mm



### M15

BLASZKA METALOWA  
(SREBRNA MATOWA)  
MOCOWANA NA GUMCE  
10 mm / RECTANGULAR  
(SILVER MATTE) METAL  
PLATE ON 10 mm ELASTIC  
BAND

wymiar / size

45 × 14 mm

pole graweru / engraving area

34 × 12 mm

\*MONTAŻ 10 mm OD BRZEGU OPRAWY. / MOUNTING 10 mm FROM THE EDGE OF COVER.



**M11\*\***

ZAPINKA METALOWA  
(SREBRNA MATOWA)  
MOCOWANA NA NIT  
Z METALOWYM ZAWIASEM  
ZAMYKANYM NA MAGNES /  
METAL CLASP  
(SILVER MATTE) FIXED  
WITH A METAL HINGE,  
CLOSING WITH MAGNETS

wymiar / size

---

32 × 12 mm

---

pole graweru / engraving area

---

28 × 8 mm

---



**M17C**

KÓŁKO FINOCHROMOWE  
MIEDZIANE, PRZYKLEJANE  
DO OPRAWY / COPPER  
FINOCHROME DOT STICKED  
TO COVER

wymiar / size

---

5 × 5 mm

---



**M17B**

KÓŁKO FINOCHROMOWE  
SREBRNE, PRZYKLEJANE  
DO OPRAWY / SILVER  
FINOCHROME DOT STICKED  
TO COVER

wymiar / size

---

5 × 5 mm

---

\*\*DOSTĘPNE W UKŁADZIE DZIENNYM I TYGODNIOWYM W KALENDARZACH I NOTESACH. / AVAILABLE FOR DAILY CALENDARS, WEEKLY CALENDARS AND NOTEBOOKS.

## DODATKI / ADD-ONS

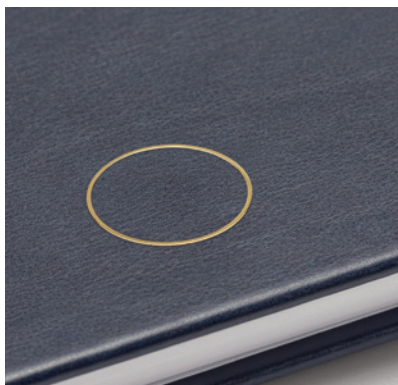

### M18A

OKRĄG FINOCHROMOWY  
ZŁOTY, PRZYKLEJANY  
DO OPRAWY / GOLDEN  
FINOCHROME CIRCLE  
STICKED TO COVER

wymiar / size

23 × 23 mm



### M18B

OKRĄG FINOCHROMOWY  
SREBRNY, PRZYKLEJANY  
DO OPRAWY / SILVER  
FINOCHROME CIRCLE  
STICKED TO COVER

wymiar / size

23 × 23 mm



### M19

OKRĄG FINOCHROMOWY  
ZŁOTY, PRZYKLEJANY  
DO OPRAWY / GOLDEN  
FINOCHROME CIRCLE  
STICKED TO COVER

wymiar / size

16 × 16 mm



### M20A

LINIA FINOCHROMOWA  
ZŁOTA PRZYKLEJANA  
DO OPRAWY / GOLDEN  
FINOCHROME LINE DOT  
STICKED TO COVER

wymiar / size

0,9 × 45 mm



### M20B

LINIA FINOCHROMOWA  
SREBRNA PRZYKLEJANA  
DO OPRAWY / SILVER  
FINOCHROME LINE DOT  
STICKED TO COVER

wymiar / size

0,9 × 45 mm

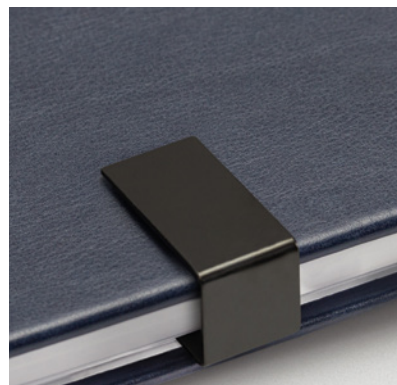

### M16\*

ZASUWKA METALOWA  
(CZARNA MAT.)  
MOCOWANA NA TYLNEJ  
OPRAWIE Z KOPERTĄ /  
METAL HASP (BLACK MAT)  
MOUNTED ON THE BACK  
COVER WITH ENVELOPE

wymiar / size

30 × 15 mm

pole graweru / engraving area

27 × 12 mm

\*DOSTĘPNE W UKŁADZIE DZIENNYM I TYGODNIOWYM W KALENDARZACH I NOTESACH. / AVAILABLE FOR DAILY CALENDARS, WEEKLY CALENDARS AND NOTEBOOKS.



### **PATKA MINI\*\***

MINI SYNTHETIC LEATHER TAB

ZAMYKANA NA MAGNES,  
MAGNES UKRYTY W OPRAWIE /  
WITH MAGNETIC CLOSURE,  
MAGNET HIDDEN IN THE FRAME



### **PATKA MAXI\*\***

MAXI SYNTHETIC LEATHER TAB

ZAMYKANA NA MAGNES  
Z MIEJSCEM NA DŁUGOPIS,  
MAGNES UKRYTY  
W OPRAWIE /  
WITH MAGNETIC CLOSURE  
AND PEN HOLDER. MAGNET  
HIDDEN IN THE FRAME

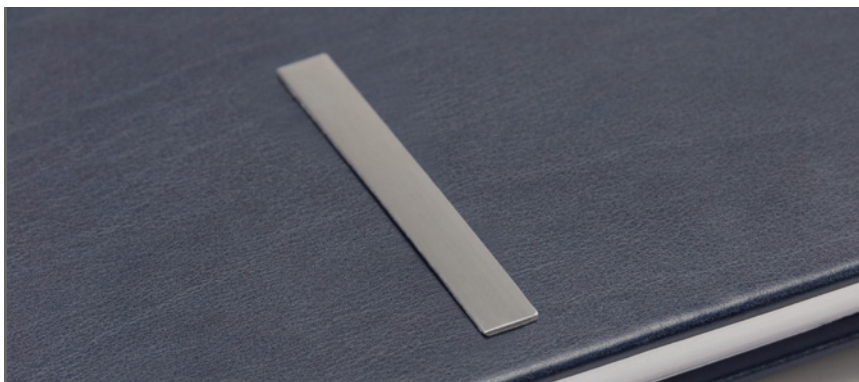

### **M21**

BLASZKA ALUMINIOWA  
POD PERSONALIZACJĘ /  
ALUMINIUM PLATE  
FOR PERSONALISATION

wymiar / size

---

70 × 8 mm

---



### **PERSONALIZACJA**

**GRAWEROWANA** (wg projektu) /  
ENGRAVED PERSONALISATION  
(according to design)

font rekomendowany /  
recommended font

---

VERDANA Regular min. 14 pkt /  
min 14 pkt. VERDANA REGULAR

---

\*\*Z WYKŁUCZENIEM OPRAW PAPIEROWYCH I rPET. / EXCLUDING PAPER AND rPET COVERS.

## DODATKI / ADD-ONS



**B1** NEW

OKRĄG BAMBUSOWY  
Z ROKIEM 3D / BAMBOO  
CIRCLE WITH 3D YEAR

wymiar / size

30 × 30 mm

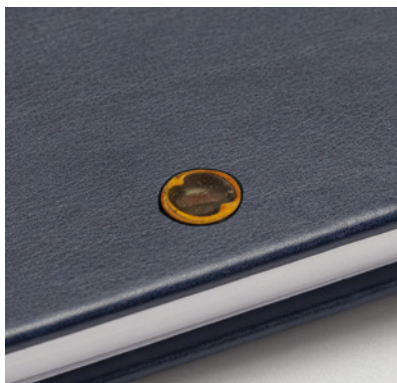

**N1** NEW

NASIONA SOSNY /  
PINE SEEDS

wymiar / size

12 × 12 mm



**G0072** NEW

DŁUGOPIS METALOWY  
AUTOMAT. Z ELEMENTEM  
KORKOWYM / AUTOMATIC  
METAL PEN WITH KORK  
ELEMENT

wymiar / size

144 × 10 mm

pole graweru / engraving area

50 × 5 mm



**G0073** NEW

DŁUGOPIS METALOWY  
AUTOMAT. Z ELEMENTEM  
BAMBUSOWYM /  
AUTOMATIC METAL PEN  
WITH BAMBOO ELEMENT

wymiar / size

144 × 10 mm

pole graweru / engraving area

50 × 5 mm



inne / other

pokrycie soft, końcówka  
dotykowa, wkład x-20 – 1 mm,  
kolor tuszu niebieski, długość  
pisania około 1000 m / barrel soft  
finished, touch tip, x-20 – 1 mm  
refill, blue ink color, writing length  
approximately 1000 m





**TRÓJKĄTNA KIESZONKA Z FOLII**  
TRIANGULAR FOIL POUCH

wymiar / size

80 × 80 mm  
100 × 100 mm  
120 × 120 mm



**PROSTOKĄTNA KIESZONKA Z FOLII**  
FOIL BUSINESS CARD POCKET

wymiar / size

90 × 60 mm

wymiar wizytówki /  
business card size

≤ 85 × 55 mm



**TASIEMKA SUBLIMACYJNA**  
(wg projektu) /SUBLIMATION  
RIBBON (according to design)

wymiar / size

8 mm  
10 mm



druk / print

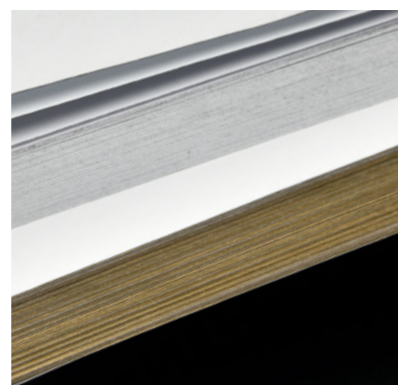

folia / foil

**BARWIONE BRZEGI\***  
COLOURED EDGES

wymiar / size

pod każdy format / for any format

projekt barwienia brzegów /  
coloured edges design

autorski / customised

zamówienie / order

min. 100 szt. / MOQ pcs.

\*NIE DOTYCZY BLOKÓW Z PAPIERU Z KAMIENIA. MOŻLIWE BARWIENIE BRZEGÓW PRZEZ Druk WG CMYK, BĄDŹ USZLACHTNIENIE FOLIA ŻŁOTĄ LUB SREBRNĄ. / DOES NOT APPLY TO STONE PAPER BLOCKS. POSSIBLE COLOURING OF THE EDGES BY PRINTING IN CMYK OR FINISHING WITH GOLD OR SILVER FOIL.



**WYKLEJKA I KOPERTA  
AUTORSKA**  
CUSTOMISED  
ENDPAPERS & ENVELOPE

wymiar / size

pod każdy format / for any format

materiał / material

papier ozdobny / decorative paper  
papier barwiony w masie /  
mass dyed paper  
papier kraftowy / kraft paper  
papier biały lub chamois /  
white or ivory paper

znakowanie / marking method

druk / print

projekt / design

autorski / customised



**WKLEJKA WYCINANA  
AUTORSKA**  
CUSTOMISED INSERT PAGE

wymiar / size

pod każdy format / for any format

materiał / material

papier barwiony w masie /  
mass dyed paper  
papier kraftowy / kraft paper

znakowanie / marking method

druk / print

projekt / design

autorski / customised



## **KALKA**

TRACING PAPER

wymiar / size

---

pod każdy format / for any format

---

znakowanie / marking method

---

druk jednostronny (wg projektu) /  
one-sided printing (according  
to design)

---

zastosowanie / application

---

obwoluta, wklejka / wrapper,  
insert page

---



## **PAPIER KRAFT I BARWIONY W MASIE DO KOPERT, WYKLEJEK, WKLEJEK I OPAKOWAŃ**

KRAFT AND MASS DYED PAPER  
FOR ENVELOPES, ENDPAPERS,  
INSERT PAGES AND PACKAGINGS

PROJEKT AUTORSKI / CUSTOMISED DESIGN



**WYKLEJKA** / ENDPAPER



**KOPERTA** / ENVELOPE



**WKLEJKA** / INSERT PAGE



**BLOK AUTORSKI** / CUSTOMISED BLOCK

## ZNAKOWANIE OPRAW / COVERS MARKING METHODS

OPRAWA COVER	TŁOCZENIE DEBOSSING	TŁOCZENIE FOLIĄ FOIL DEBOSSING	GRAWER ENGRAVING	SZYCIE SEWING	DRUK PRINT
<b>rPET</b>					✓
<b>QUERK</b>					✓
<b>RE-COVER</b>				✓	✓
<b>SAVANA</b>	✓		✓	✓	✓
<b>NATURA</b>	✓	✓	✓	✓	✓
<b>GAMBO</b>	✓			✓	✓
<b>CROSS</b>	✓		✓	✓	✓
<b>CANVAS</b>	✓		✓	✓	✓
<b>IDEO</b>	✓	✓	✓	✓	✓
<b>PIKO</b>	✓		✓	✓	✓
<b>GUMA</b>	✓	✓	✓	✓	✓
<b>IMAGE</b>	✓	✓	✓	✓	✓
<b>CARBON</b>	✓		✓	✓	✓
<b>COLORADO</b>	✓	✓	✓	✓	✓
<b>DURO</b>	✓			✓	✓
<b>KRAFT</b>	✓	✓	✓	✓	✓
<b>FLESZ</b>	✓	✓	✓	✓	✓
<b>VIVELA</b>	✓	✓	✓	✓	✓
<b>ITALIANO</b>	✓	✓	✓		

ZESTAWIENIE ROKU / YEAR DESIGN

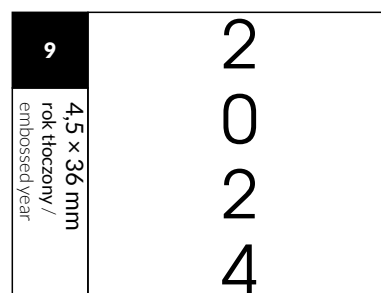
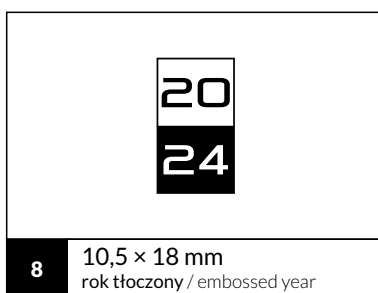
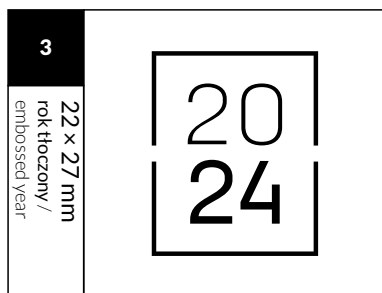

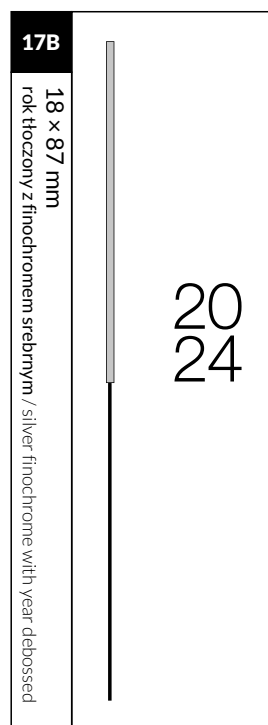
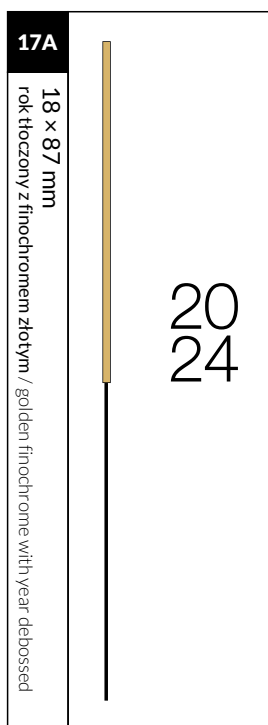
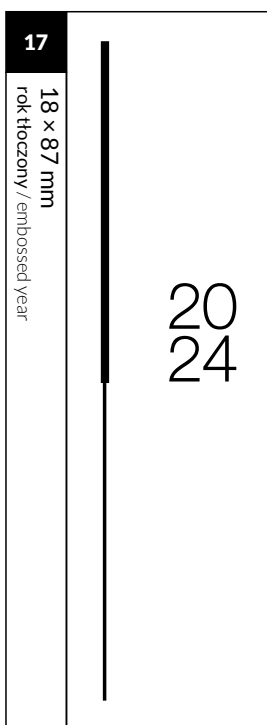
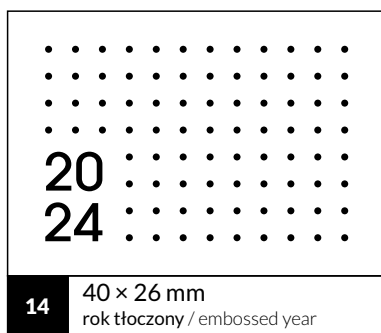
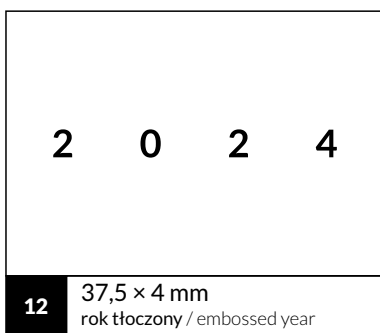
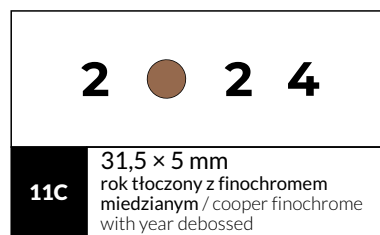
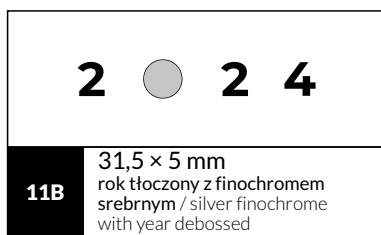
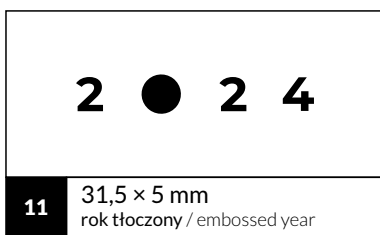
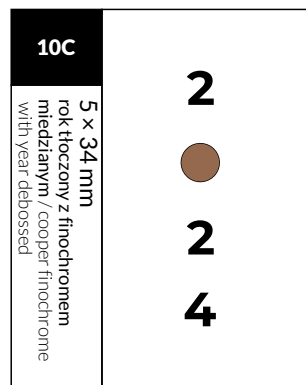
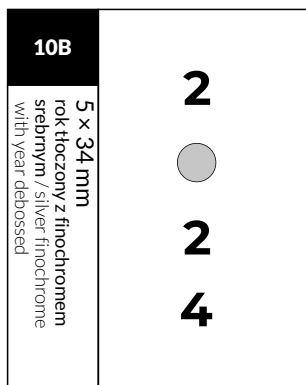
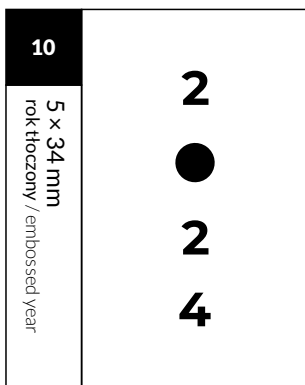

# ZESTAWIENIE ROKU / YEAR DESIGN

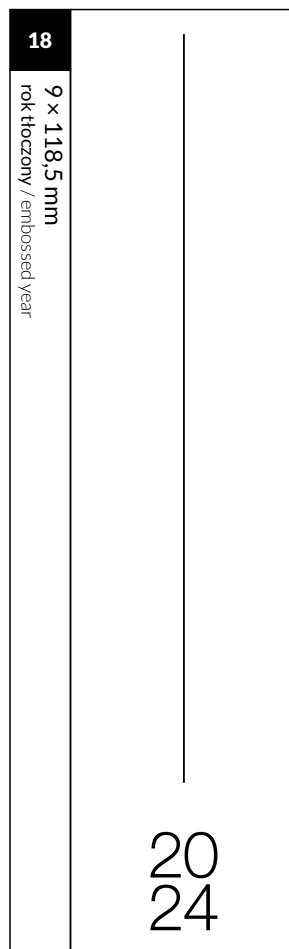
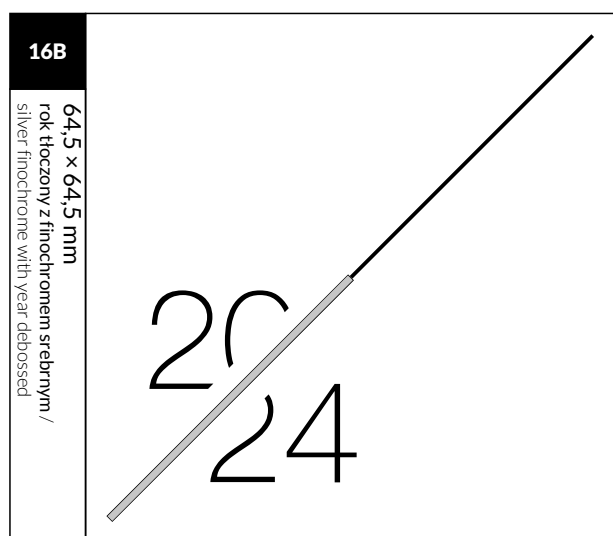
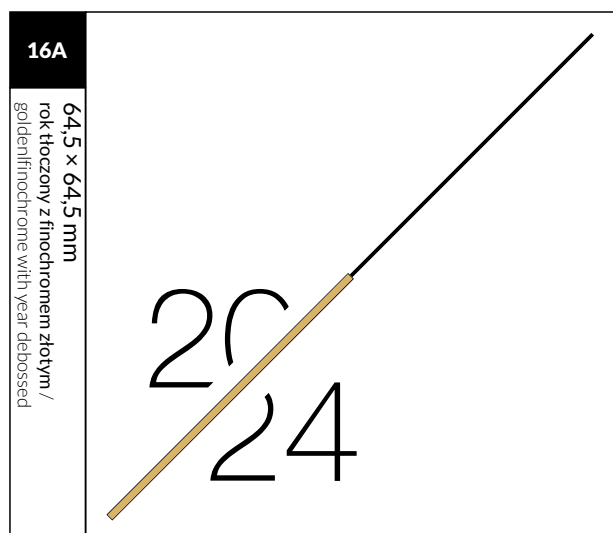
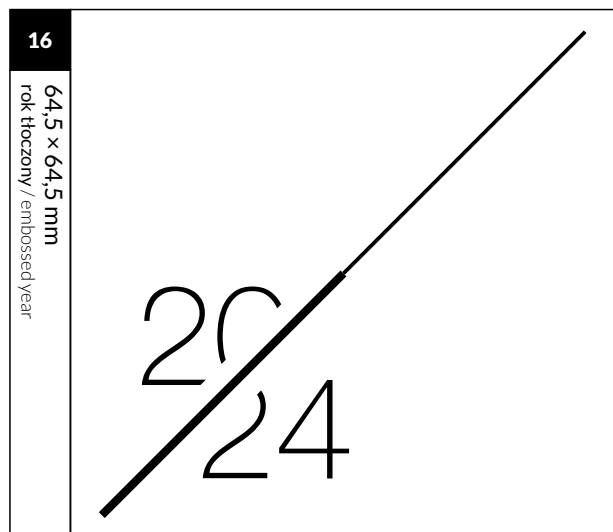



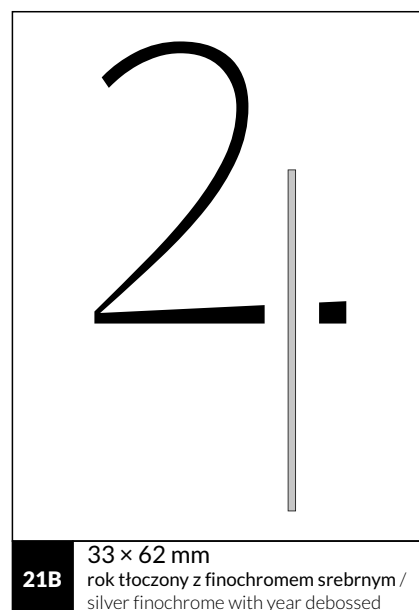
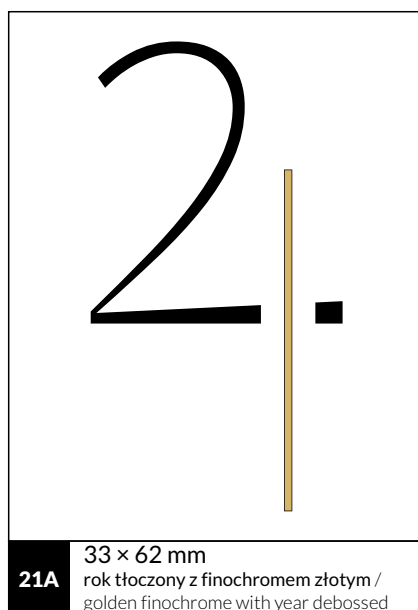
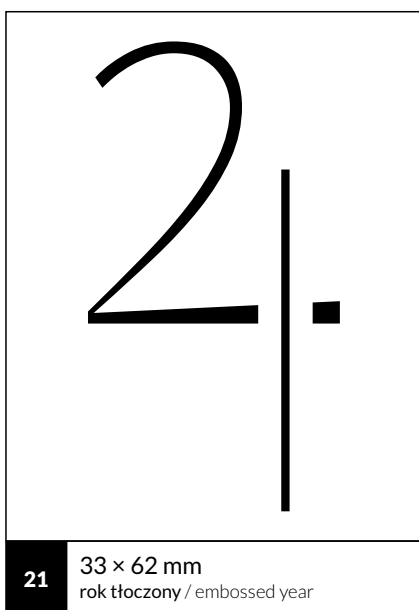
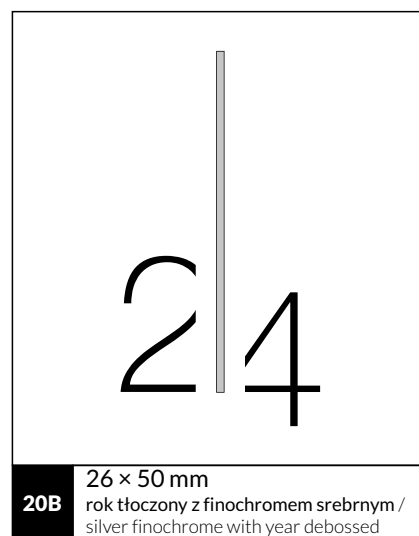
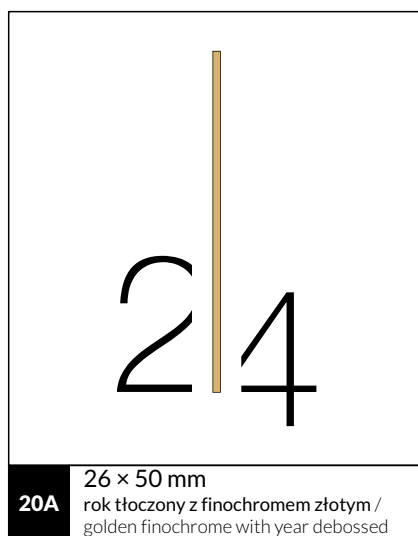
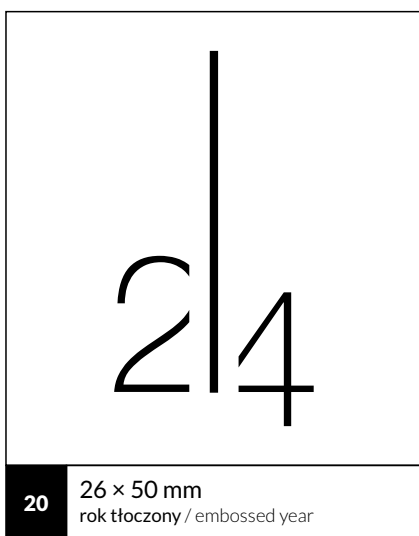
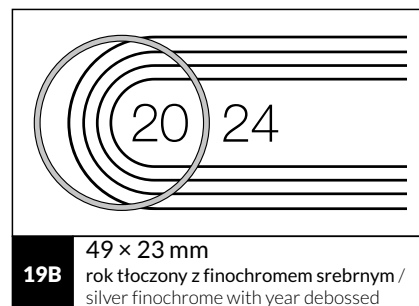
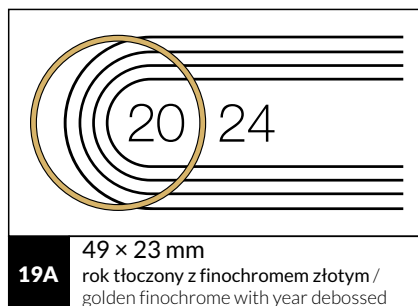
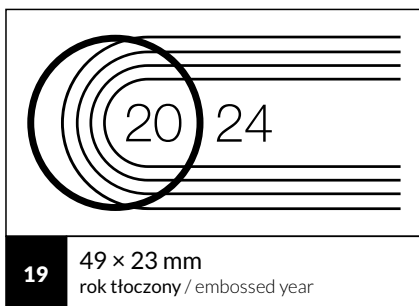

## ZESTAWIENIE ROKU / YEAR DESIGN

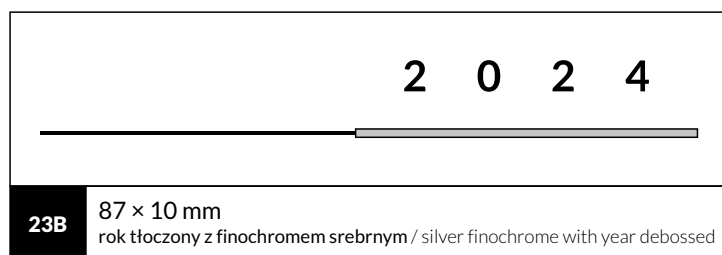
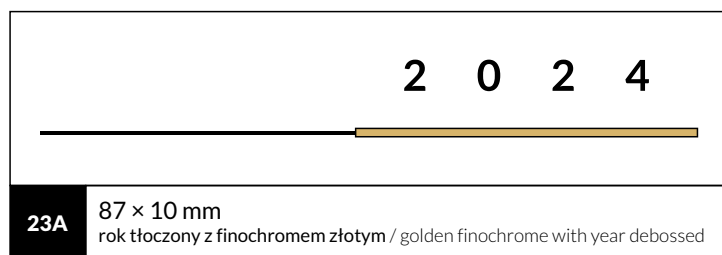
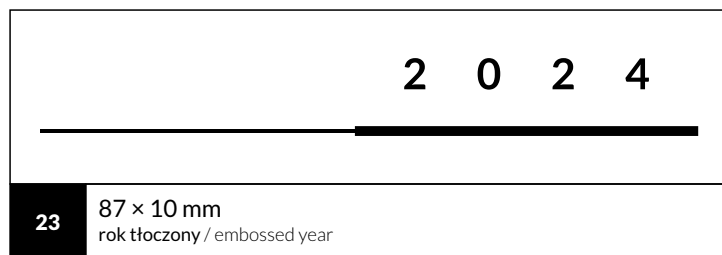
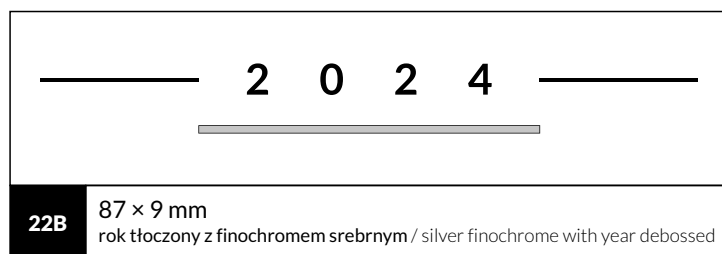
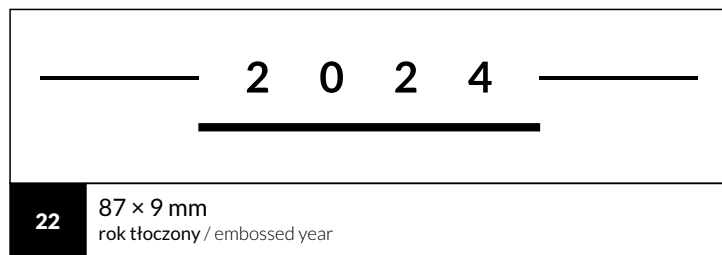

# ŁĄCZENIE OPRAW / COVER COMBINATIONS

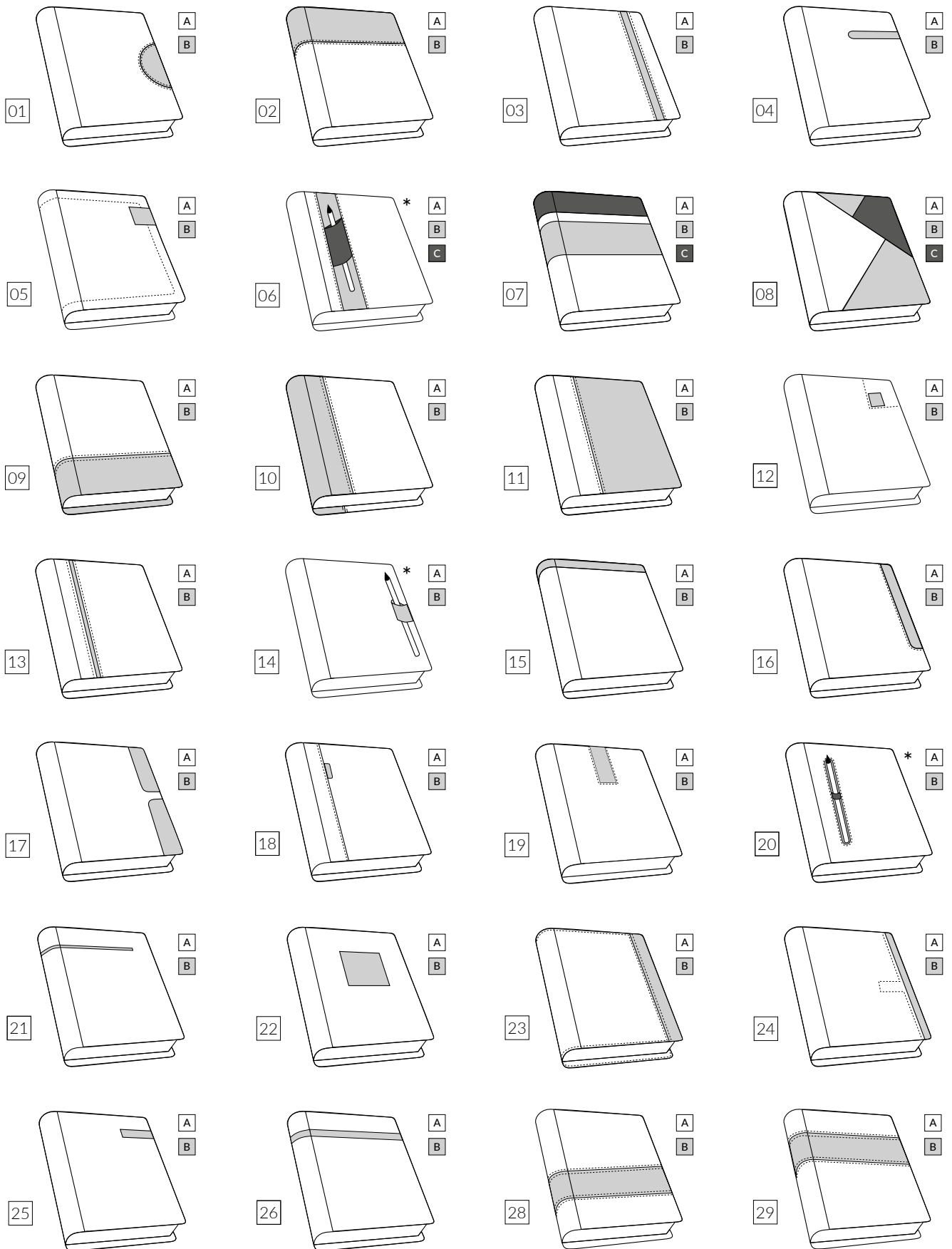

\*SZLUFKA NA DŁUGOPIS. / ELASTIC PEN HOLDER.

PRZEDSTAWIONA NUMERACJA JEST WYKAZEM DOSTĘPNYCH ŁĄCZEŃ OPRAW Z WYKLUCZENIEM OPRAW PAPIEROWYCH I rPET. / THE NUMBERING SHOWN IS THE LIST OF THE COVER COMBINATIONS AVAILABLE, EXCLUDING PAPER AND rPET COVERS.

# MATRYCE WIELKOFORMATOWE / LARGE FORMAT STAMPS

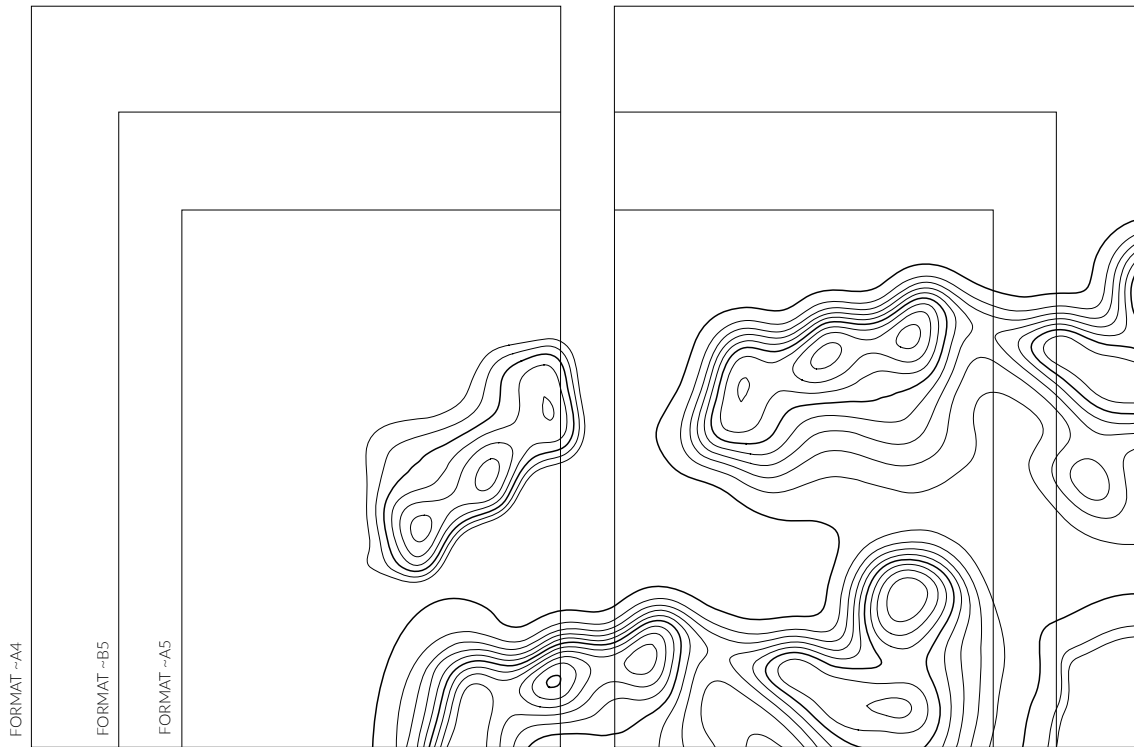

**1** 294 × 200 mm  
wzór tłoczony / debossed pattern

SZEROKOŚĆ GRZBIETU ZALEŻNA OD ZAMAWIANEGO BLOKU. /  
WIDTH OF THE SPINE DEPENDING ON THE ORDERED INNER BLOCK.

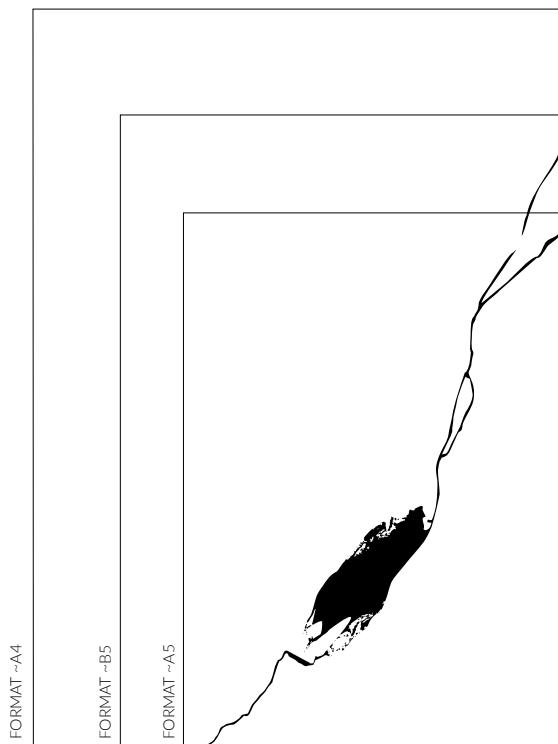

**2** 167 × 240 mm  
wzór tłoczony / debossed pattern

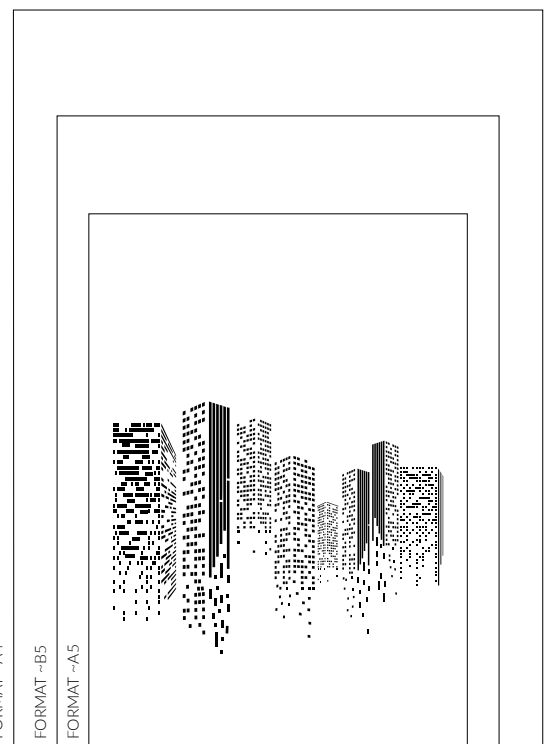

**3** 125 × 96 mm  
wzór tłoczony / debossed pattern

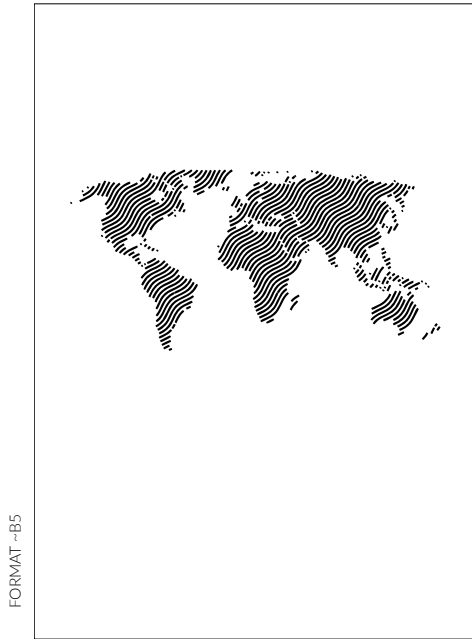

**4** 140 × 69 mm  
wzór tłoczony / debossed pattern

MATRYCA DOSTOSOWANA DO FORMATÓW -A5 I -A4 /  
STAMPING ADAPTED TO -A5 AND -A4 FORMATS

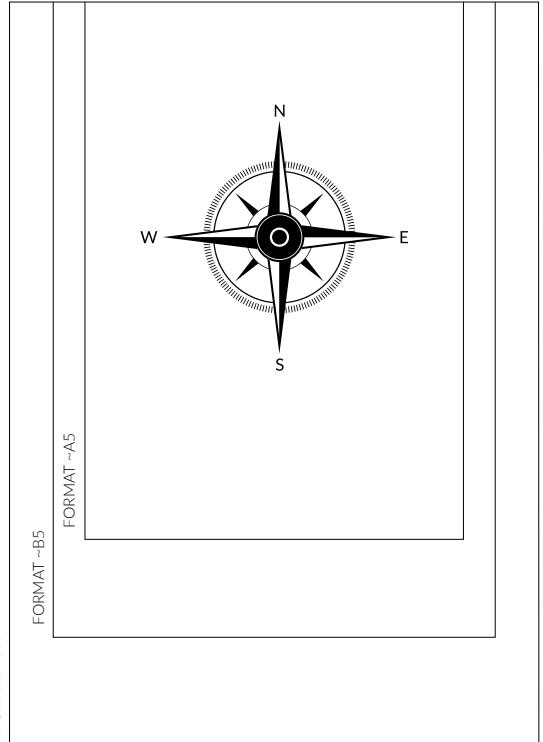

**5** 101 × 101 mm  
wzór tłoczony / debossed pattern

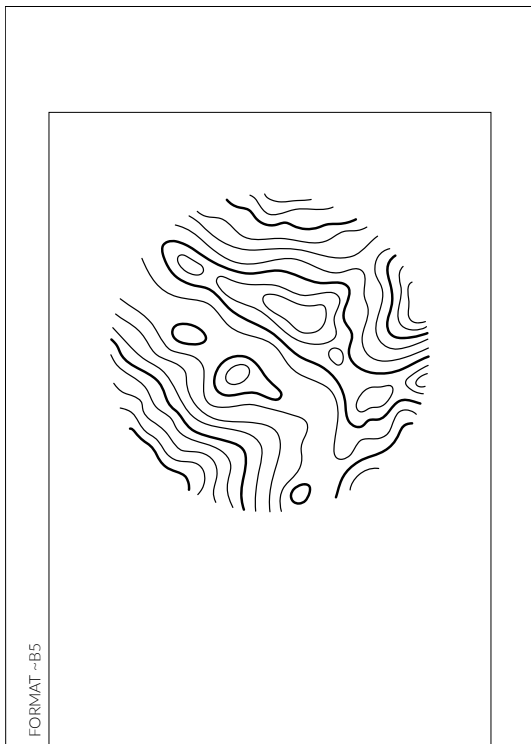

**6** 121 × 120 mm  
wzór tłoczony / debossed pattern

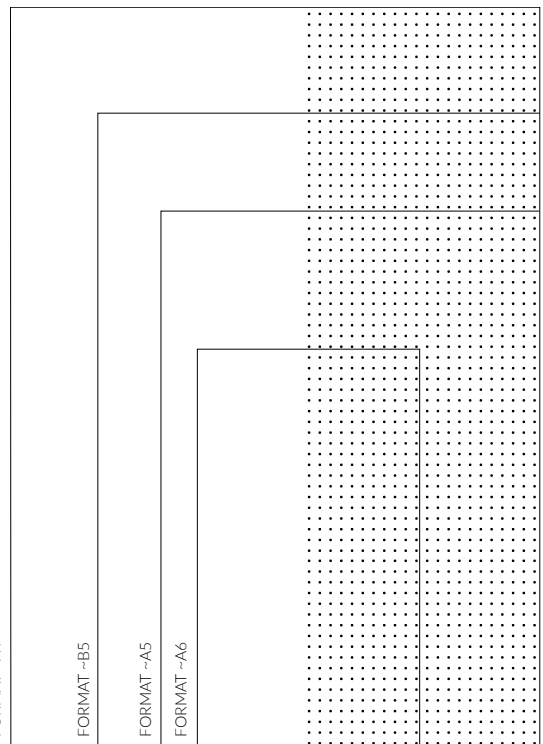

**7** 86 × 284 mm  
wzór tłoczony / debossed pattern

PREZENTOWANE MATRYCE DO TŁOCZEŃ WIELKOFORMATOWYCH MOGĄ ZOSTAĆ UŻYTE BEZPŁATNIE DO DOWOLNEGO ZAMÓWIENIA. W TAKIM PRZYPADKU KLIENT PONOSI KOSZT WYŁĄCZNIE SAMEJ USŁUGI TŁOCZENIA ZGODNIE Z OBOWIĄZUJĄCYM CENNIKIEM (BEZ KOSZTÓW MATRYCY). / PRESENTED STAMPING USED FOR THE LARGE FORMAT DEBOSSINGS CAN BE USED FREE OF CHARGE FOR ANY ORDER. IN THIS CASE, THE CUSTOMER PAYS ONLY THE COST OF THE STAMPING SERVICE IN ACCORDANCE WITH THE APPLICABLE PRICE LIST (WITHOUT THE COSTS OF THE STAMP).

BLOKI KALENDARZY DZIENNYCH / DAILY CALENDARS LAYOUTS

501D 503D 508D

227+139

## 14 Środa

We / Mi / Me / Cp

**SIERPIEŃ**  
August, August, Agosto, Септень

**TYDZIEŃ 33**

Alfreda, Euzebiusza

Week, Woche, Settimana, Тиждень

---

7 \_\_\_\_\_

8 \_\_\_\_\_

9 \_\_\_\_\_

10 \_\_\_\_\_

11 \_\_\_\_\_

12 \_\_\_\_\_

13 \_\_\_\_\_

14 \_\_\_\_\_

15 \_\_\_\_\_

16 \_\_\_\_\_

17 \_\_\_\_\_

18 \_\_\_\_\_

19 \_\_\_\_\_

---

Wszystko, w czym jesteś dobry, przyczynia się do szczęścia.  
*Bertrand Russell*

228+138

## 15 Czwartek

Th / Do / Gi / Чт

**SIERPIEŃ**  
August, August, Agosto, Септень

**TYDZIEŃ 33**

Wniebowzięcie NMP  
Święto Wojska Polskiego  
Marii, Napoleona

Week, Woche, Settimana, Тиждень

---

7 \_\_\_\_\_

8 \_\_\_\_\_

9 \_\_\_\_\_

10 \_\_\_\_\_

11 \_\_\_\_\_

12 \_\_\_\_\_

13 \_\_\_\_\_

14 \_\_\_\_\_

15 \_\_\_\_\_

16 \_\_\_\_\_

17 \_\_\_\_\_

18 \_\_\_\_\_

19 \_\_\_\_\_

---

My nie tyle potrzebujemy pomocy przyjaciół, co wiary, że taką pomoc możemy uzyskać.  
*Epkur*

	STYCZEŃ	LUTY	MARZEC	KWIECIEŃ	MAJ	CZERWIEC
1	1 2 3 4 5	5 6 7 8 9	9 10 11 12 13	14 15 16 17 18	18 19 20 21 22	22 23 24 25 26
14	1 8 15 22 29	5 12 19 26	4 11 18 25	1 8 15 22 29	6 13 20 27	3 10 17 24
15	2 9 16 23 30	6 13 20 27	5 12 19 26	2 9 16 23 30	7 14 21 28	4 11 18 25
16	3 10 17 24 31	7 14 21 28	6 13 20 27	3 10 17 24	1 8 15 22 29	5 12 19 26
17	4 11 18 25	1 8 15 22 29	7 14 21 28	4 11 18 25	2 9 16 23 30	6 13 20 27
18	5 12 19 26	2 9 16 23 30	1 8 15 22 29	5 12 19 26	3 10 17 24 31	7 14 21 28
19	6 13 20 27	3 10 17 24	2 9 16 23 30	6 13 20 27	4 11 18 25	1 8 15 22 29
20	7 14 21 28	4 11 18 25	3 10 17 24 31	7 14 21 28	5 12 19 26	2 9 16 23 30



KALENDARZ / CALENDAR		501D	503D	508D	REGISTRY / INDEX		perforacja narożników corner perforation
format / format		200 × 280 mm ~A4	143 × 203 mm ~A5	162 × 240 mm ~B5	drukowane printed	wycinane tabbed	
ilość stron / pages		368	368	368			
papier biały / white paper druk / print	szaro-bordowy grey-maroon	✓	✓	✓	✓	✓	✓
	szaro-granatowy grey-dark blue	✓	✓	✓	✓	✓	✓
	szaro-grafitowy grey-graphite						
papier chamois/ ivory paper druk / print	szaro-bordowy grey-maroon	✓	✓	✓	✓	✓	✓
	szaro-granatowy grey-dark blue	✓	✓	✓	✓	✓	✓
	szaro-grafitowy grey-graphite						
papier z recyklingu / recycled paper druk / print	szaro-grafitowy grey-graphite		✓		✓		
papier z trawy / grass paper druk / print	szaro-grafitowy grey-graphite						
papier z kamienia / stone paper druk / print	szaro-grafitowy grey-graphite						
język / language		PL GB DE IT UA					
dane personalne / personal data		✓	✓	✓			
licznik dni / day counter		✓	✓	✓			
numeracja tygodni / week numbering		✓	✓	✓			
karta planowania celów / goal planning sheet		✓	✓	✓			
święta międzynarodowe / international holidays		✓	✓	✓			
kalendarz skrócony / shortened calendar 2023-2025		✓	✓	✓			
planer roczny / annual planner		✓	✓	✓			
planer miesięczny / monthly planner		✓	✓	✓			
kalendarz roczny / annual calendar 2024		✓	✓	✓			
imieniny / name day		✓	✓	✓			
aforyzmy / aphorisms		✓	✓	✓			
oświadczenie drogowe / accident statement		✓	✓	✓			
notes / notebook		✓	✓	✓			
mapy / maps							

# BLOKI KALENDARZY DZIENNYCH / DAILY CALENDARS LAYOUTS

## 506D

162+204

### 10 Poniedziałek

CZERWIEC  
Mo / Mo / Lu / Fr

June, Juni, Giugno, Нептун

---

TYDZIEŃ 24

Bogumiła, Malgorzaty

Week, Woche, Settimana, Тиждень

---

7 \_\_\_\_\_

8 \_\_\_\_\_

9 \_\_\_\_\_

10 \_\_\_\_\_

11 \_\_\_\_\_

12 \_\_\_\_\_

13 \_\_\_\_\_

14 \_\_\_\_\_

15 \_\_\_\_\_

16 \_\_\_\_\_

17 \_\_\_\_\_

18 \_\_\_\_\_

19 \_\_\_\_\_

20 \_\_\_\_\_

21 \_\_\_\_\_

22 \_\_\_\_\_

23 \_\_\_\_\_

24 \_\_\_\_\_

25 \_\_\_\_\_

26 \_\_\_\_\_

27 \_\_\_\_\_

28 \_\_\_\_\_

29 \_\_\_\_\_

30 \_\_\_\_\_

31 \_\_\_\_\_

Wygrzwyj bez pycny, przogrywaj bez urazy.  
Bruce Lee

STYCZEN	LUTY	MARZEC	KWIECIEŃ	MAJ	CZERWIEC
1 2 3 4 5	6 7 8 9	10 11 12 13	14 15 16 17 18	19 20 21 22	23 24 25 26
27 28 29	30 31	1 2 3 4 5	6 7 8 9 10	11 12 13 14	15 16 17 18
19 20 21 22	23 24 25 26	27 28 29 30	31	1 2 3 4	5 6 7 8 9
10 11 12 13	14 15 16 17 18	19 20 21 22	23 24 25 26	27 28 29	30 31
1 2 3 4 5	6 7 8 9	10 11 12 13	14 15 16 17 18	19 20 21 22	23 24 25 26
27 28 29	30 31	1 2 3 4 5	6 7 8 9 10	11 12 13 14	15 16 17 18
19 20 21 22	23 24 25 26	27 28 29 30	31	1 2 3 4	5 6 7 8 9

163+203

### 11 Wtorek

CZERWIEC  
Tu / Tu / We / Fr

June, Juni, Giugno, Нептун

---

TYDZIEŃ 24

Barnaby, Feliksa

Week, Woche, Settimana, Тиждень

---

7 \_\_\_\_\_

8 \_\_\_\_\_

9 \_\_\_\_\_

10 \_\_\_\_\_

11 \_\_\_\_\_

12 \_\_\_\_\_

13 \_\_\_\_\_

14 \_\_\_\_\_

15 \_\_\_\_\_

16 \_\_\_\_\_

17 \_\_\_\_\_

18 \_\_\_\_\_

19 \_\_\_\_\_

20 \_\_\_\_\_

21 \_\_\_\_\_

22 \_\_\_\_\_

23 \_\_\_\_\_

24 \_\_\_\_\_

25 \_\_\_\_\_

26 \_\_\_\_\_

27 \_\_\_\_\_

28 \_\_\_\_\_

29 \_\_\_\_\_

30 \_\_\_\_\_

31 \_\_\_\_\_

Krytyka jest czymś, czego możemy łatwo uniknąć  
nie mówiąc nic, nie robiąc nic i będąc nikim.  
Aristoteles

LIPIEC	SIERPIEŃ	WRZEŚIEŃ	PAŹDZIERNIK	LISTOPAD	GRUDZIEŃ
1 2 3 4 5 6 7 8 9 10 11 12 13 14 15 16 17 18 19 20 21 22 23 24 25 26 27 28 29 30 31	1 2 3 4 5 6 7 8 9 10 11 12 13 14 15 16 17 18 19 20 21 22 23 24 25 26 27 28 29 30 31	1 2 3 4 5 6 7 8 9 10 11 12 13 14 15 16 17 18 19 20 21 22 23 24 25 26 27 28 29 30 31	1 2 3 4 5 6 7 8 9 10 11 12 13 14 15 16 17 18 19 20 21 22 23 24 25 26 27 28 29 30 31	1 2 3 4 5 6 7 8 9 10 11 12 13 14 15 16 17 18 19 20 21 22 23 24 25 26 27 28 29 30 31	1 2 3 4 5 6 7 8 9 10 11 12 13 14 15 16 17 18 19 20 21 22 23 24 25 26 27 28 29 30 31

## 510D

5+361

### 5 Friday

JANUARY

1

---

7 \_\_\_\_\_

8 \_\_\_\_\_

9 \_\_\_\_\_

10 \_\_\_\_\_

11 \_\_\_\_\_

12 \_\_\_\_\_

13 \_\_\_\_\_

14 \_\_\_\_\_

15 \_\_\_\_\_

16 \_\_\_\_\_

17 \_\_\_\_\_

18 \_\_\_\_\_

19 \_\_\_\_\_

20 \_\_\_\_\_

21 \_\_\_\_\_

22 \_\_\_\_\_

23 \_\_\_\_\_

24 \_\_\_\_\_

25 \_\_\_\_\_

26 \_\_\_\_\_

27 \_\_\_\_\_

28 \_\_\_\_\_

29 \_\_\_\_\_

30 \_\_\_\_\_

31 \_\_\_\_\_

I	II	III	IV	V	VI
1 2 3 4 5	6 7 8 9	10 11 12 13	14 15 16 17 18	19 20 21 22	23 24 25 26
27 28 29 30 31	1 2 3 4 5	6 7 8 9 10	11 12 13 14	15 16 17 18	19 20 21 22
23 24 25 26	27 28 29 30	31	1 2 3 4	5 6 7 8 9	10 11 12 13

6+360

### 6 Saturday

JANUARY

1

---

7 \_\_\_\_\_

8 \_\_\_\_\_

9 \_\_\_\_\_

10 \_\_\_\_\_

11 \_\_\_\_\_

12 \_\_\_\_\_

13 \_\_\_\_\_

14 \_\_\_\_\_

15 \_\_\_\_\_

16 \_\_\_\_\_

17 \_\_\_\_\_

18 \_\_\_\_\_

19 \_\_\_\_\_

20 \_\_\_\_\_

21 \_\_\_\_\_

22 \_\_\_\_\_

23 \_\_\_\_\_

24 \_\_\_\_\_

25 \_\_\_\_\_

26 \_\_\_\_\_

27 \_\_\_\_\_

28 \_\_\_\_\_

29 \_\_\_\_\_

30 \_\_\_\_\_

31 \_\_\_\_\_

7+359

### 7 Sunday

JANUARY

1

---

7 \_\_\_\_\_

8 \_\_\_\_\_

9 \_\_\_\_\_

10 \_\_\_\_\_

11 \_\_\_\_\_

12 \_\_\_\_\_

13 \_\_\_\_\_

14 \_\_\_\_\_

15 \_\_\_\_\_

16 \_\_\_\_\_

17 \_\_\_\_\_

18 \_\_\_\_\_

19 \_\_\_\_\_

20 \_\_\_\_\_

21 \_\_\_\_\_

22 \_\_\_\_\_

23 \_\_\_\_\_

24 \_\_\_\_\_

25 \_\_\_\_\_

26 \_\_\_\_\_

27 \_\_\_\_\_

28 \_\_\_\_\_

29 \_\_\_\_\_

30 \_\_\_\_\_

31 \_\_\_\_\_

VII	VIII	IX	X	XI	XII
1 2 3 4 5 6 7 8 9 10 11 12 13 14 15 16 17 18 19 20 21 22 23 24 25 26 27 28 29 30 31	1 2 3 4 5 6 7 8 9 10 11 12 13 14 15 16 17 18 19 20 21 22 23 24 25 26 27 28 29 30 31	1 2 3 4 5 6 7 8 9 10 11 12 13 14 15 16 17 18 19 20 21 22 23 24 25 26 27 28 29 30 31	1 2 3 4 5 6 7 8 9 10 11 12 13 14 15 16 17 18 19 20 21 22 23 24 25 26 27 28 29 30 31	1 2 3 4 5 6 7 8 9 10 11 12 13 14 15 16 17 18 19 20 21 22 23 24 25 26 27 28 29 30 31	1 2 3 4 5 6 7 8 9 10 11 12 13 14 15 16 17 18 19 20 21 22 23 24 25 26 27 28 29 30 31



KALENDARZ / CALENDAR		506D	510D	REGISTRY / INDEX		perforacja narożników corner perforation
format / format		110 × 160 mm ~A6	143 × 203 mm ~A5	drukowane printed	wycinane tabbed	
ilość stron / pages		368	368			
papier biały / white paper druk / print	szaro-bordowy grey-maroon					
	szaro-granatowy grey-dark blue					
	szaro-grafitowy grey-graphite	✓	✓	✓		
papier chamois/ ivory paper druk / print	szaro-bordowy grey-maroon					
	szaro-granatowy grey-dark blue					
	szaro-grafitowy grey-graphite					
papier z recyklingu / recycled paper druk / print	szaro-grafitowy grey-graphite					
papier z trawy / grass paper druk / print	szaro-grafitowy grey-graphite					
papier z kamienia / stone paper druk / print	szaro-grafitowy grey-graphite					
język / language		PL GB DE IT UA	GB			
dane personalne / personal data		✓	✓			
licznik dni / day counter		✓	✓			
numeracja tygodni / week numbering		✓	✓			
karta planowania celów / goal planning sheet		✓	✓			
święta międzynarodowe / international holidays		✓	✓			
kalendarz skrócony / shortened calendar 2023-2025		✓	✓			
planer roczny / annual planner		✓	✓			
planer miesięczny / monthly planner		✓	✓			
kalendarz roczny / annual callendar 2024		✓	✓			
imieniny / name day		✓				
aforyzmy / aphorisms		✓				
oświadczenie drogowe / accident statement						
notes / notebook		✓	✓			
mapy / maps						

# BLOKI KALENDARZY TYGODNIOWYCH / WEEKLY CALENDARS LAYOUTS

## 502T 507T

**GRUDZIEŃ**  
December, Dezember, Dicembre, Еризынь

358+8 | **23** | **Poniedziałek**  
Mo / Mo / Lu / Pt

359+7 | **24** | **Wtorek**  
Tu / Di / Ma / Br

360+6 | **25** | **Środa**  
We / Mi / Me / Cp

Wiktoria, Sławomy

WIGILIA BOŻEGO NARODZENIA  
Adama, Ewy

BOŻE NARODZENIE  
Eugenii, Anastazji

7 \_\_\_\_\_

8 \_\_\_\_\_

9 \_\_\_\_\_

10 \_\_\_\_\_

11 \_\_\_\_\_

12 \_\_\_\_\_

13 \_\_\_\_\_

14 \_\_\_\_\_

15 \_\_\_\_\_

16 \_\_\_\_\_

17 \_\_\_\_\_

18 \_\_\_\_\_

STYCZEŃ    LUTY    MARZEC    KWIECIEŃ    MAJ    CZERWIEC

T	1 2 3 4 5	5 6 7 8 9	9 10 11 12 13	14 15 16 17 18	18 19 20 21 22	22 23 24 25 26
Wn	1 8 15 22 29	5 12 19 26	4 11 18 25	1 8 15 22 29	6 13 20 27	3 10 17 24
Wt	2 9 16 23 30	6 13 20 27	5 12 19 26	2 9 16 23 30	7 14 21 28	4 11 18 25
Śr	3 10 17 24 31	7 14 21 28	6 13 20 27	3 10 17 24	1 8 15 22 29	8 12 19 26
Cz	4 11 18 25	1 8 15 22 29	7 14 21 28	4 11 18 25	2 9 16 23 30	6 13 20 27
Pt	5 12 19 26	2 9 16 23	1 8 15 22 29	5 12 19 26	3 10 17 24 31	7 14 21 28
So	6 13 20 27	3 10 17 24	2 9 16 23 30	6 13 20 27	4 11 18 25	1 8 15 22 29
Nd	7 14 21 28	4 11 18 25	3 10 17 24 31	7 14 21 28	5 12 19 26	2 9 16 23 30

**TYDZIEŃ 52**  
Week, Woche, Settimana, Тиждень

361+5 | **26** | **Czwartek**  
Th / Do / Gi / Hr

362+4 | **27** | **Piątek**  
Fr / Fr / Ve / Ft

363+3 | **28** | **Sobota**  
Sa / Sa / Sa / Co

BOŻE NARODZENIE  
Dionizego, Szczepana

NARODOWY DZIEŃ ZWYCIĘSKIEGO  
POWSTANIA WIELKOPOLSKIEGO  
Kosmy, Damiana

Cezarego, Teofila

7 \_\_\_\_\_

8 \_\_\_\_\_

9 \_\_\_\_\_

10 \_\_\_\_\_

11 \_\_\_\_\_

12 \_\_\_\_\_

13 \_\_\_\_\_

14 \_\_\_\_\_

15 \_\_\_\_\_

16 \_\_\_\_\_

17 \_\_\_\_\_

18 \_\_\_\_\_

364+2 | **29** | **Niedziela**  
Su / So / Do / Hg

Dawida, Jonatana

Nie możesz kontrolować zachowania  
innych, ale zawsze możesz wybrać  
sposób, w jaki na nie reagujesz.  
Roy T. Bennett

LIPIEC    SIERPIEŃ    WRZESIEŃ    PAŹDZIERNIK    LISTOPAD    GRUDZIEŃ

T	27 28 29 30 31	31 32 33 34 35	35 36 37 38 39 40	40 41 42 43 44	44 45 46 47 48	48 49 50 51 52 1
Wn	1 8 15 22 29	5 12 19 26	2 9 16 23 30	7 14 21 28	4 11 18 25	2 9 16 23 30
Wt	2 9 16 23 30	6 13 20 27	3 10 17 24	1 8 15 22 29	5 12 19 26	3 10 17 24 31
Śr	3 10 17 24 31	7 14 21 28	4 11 18 25	2 9 16 23 30	6 13 20 27	4 11 18 25
Cz	4 11 18 25	1 8 15 22 29	5 12 19 26	3 10 17 24 31	7 14 21 28	5 12 19 26
Pt	5 12 19 26	2 9 16 23 30	6 13 20 27	4 11 18 25	1 8 15 22 29	6 13 20 27
So	6 13 20 27	3 10 17 24 31	7 14 21 28	5 12 19 26	2 9 16 23 30	7 14 21 28
Nd	7 14 21 28	4 11 18 25	1 8 15 22 29	6 13 20 27	3 10 17 24	1 8 15 22 29



KALENDARZ / CALENDAR		502T	507T	REGISTRY / INDEX		perforacja narożników corner perforation
format / format		208 × 260 mm ~A4	167 × 240 mm ~B5	drukowane printed	wycinane tabbed	
ilość stron / pages		160	160			
papier biały / white paper druk / print	szaro-bordowy grey-maroon	✓	✓	✓	✓	✓
	szaro-granatowy grey-dark blue	✓	✓	✓	✓	✓
	szaro-grafitowy grey-graphite					
papier chamois/ ivory paper druk / print	szaro-bordowy grey-maroon	✓	✓	✓	✓	✓
	szaro-granatowy grey-dark blue	✓	✓	✓	✓	✓
	szaro-grafitowy grey-graphite					
papier z recyklingu / recycled paper druk / print	szaro-grafitowy grey-graphite					
papier z trawy / grass paper druk / print	szaro-grafitowy grey-graphite		✓	✓		
papier z kamienia / stone paper druk / print	szaro-grafitowy grey-graphite					
język / language		PL GB DE IT UA				
dane personalne / personal data		✓	✓			
licznik dni / day counter		✓	✓			
numeracja tygodni / week numbering		✓	✓			
karta planowania celów / goal planning sheet		✓	✓			
święta międzynarodowe / international holidays		✓	✓			
kalendarz skrócony / shortened calendar 2023-2025		✓	✓			
planer roczny / annual planner		✓	✓			
planer miesięczny / monthly planner		✓	✓			
kalendarz roczny / annual calendar 2024		✓	✓			
imieniny / name day		✓	✓			
aforyzmy / aphorisms		✓	✓			
oświadczenie drogowe / accident statement		✓	✓			
notes / notebook		✓	✓			
mapy / maps						

# 504T

GRUDZIEŃ / STYCZEŃ <small>December, Dezember, Dicembre, Грудень / January, Januar, Gennaio, Січень</small>	TYDZIEŃ 1 <small>Week, Woche, Settimana, Тиждень</small>
<b>30</b> <b>Poniedziałek</b> <small>Mo / Mo / Lu / Пн</small> <span style="float: right;">Eugeniusza Sabiny</span>	<b>2</b> <b>Czwartek</b> <small>Th / Do / Gi / Чт</small> <span style="float: right;">Izydora Makarego</span>
<b>31</b> <b>Wtorek</b> <small>Tu / Di / Ma / Вт</small> SYLWESTER <span style="float: right;">Sylwestra Sebastiana</span>	<b>3</b> <b>Piątek</b> <small>Fr / Fr / Ve / Пт</small> <span style="float: right;">Danuty Genowefy</span>
<b>1</b> <b>Środa</b> <small>We / Mi / Me / Ср</small> NOWY ROK <span style="float: right;">Mieczysława Mieszka</span>	<b>4</b> <b>Sobota</b> <small>Sa / Sa / Sa / Сб</small> <span style="float: right;">Anieli Eugeniusza</span>
	<b>5</b> <b>Niedziela</b> <small>Su / So / Do / Дд</small> <span style="float: right;">Edwarda Szymona</span>

GRUDZIEŃ 2024



KALENDARZ / CALENDAR		504T	REGISTRY / INDEX		
format / format		84 × 151 mm format kieszonkowy pocket-sized format	drukowane printed	wycinane tabbed	perforacja narożników corner perforation
ilość stron / pages		128			
papier biały / white paper druk / print	szaro-bordowy grey-maroon				
	szaro-granatowy grey-dark blue				
	szaro-grafitowy grey-graphite	✓	✓		
papier chamois/ ivory paper druk / print	szaro-bordowy grey-maroon				
	szaro-granatowy grey-dark blue				
	szaro-grafitowy grey-graphite	✓	✓		
papier z recyklingu / recycled paper druk / print	szaro-grafitowy grey-graphite				
papier z trawy / grass paper druk / print	szaro-grafitowy grey-graphite				
papier z kamienia / stone paper druk / print	szaro-grafitowy grey-graphite				
język / language		PL GB DE IT UA			
dane personalne / personal data		✓			
licznik dni / day counter					
numeracja tygodni / week numbering		✓			
karta planowania celów / goal planning sheet					
święta międzynarodowe / international holidays		✓			
kalendarz skrócony / shortened calendar 2023-2025		✓			
planer roczny / annual planner					
planer miesięczny / monthly planner					
kalendarz roczny / annual calendar 2024					
imieniny / name day		✓			
aforyzmy / aphorisms					
oświadczenie drogowe / accident statement					
notes / notebook		✓			
mapy / maps					

# 505T

Blank weekly calendar layout for February (Luty) with a spiral binding at the bottom. The layout includes a header for the month and week, followed by a grid of days with space for notes.

**LUTY**  
February, Februar, Febbraio, Лютый

**Tydzień 6**  
Week, Woche, Settimana, Тиждень

5	6	7	8	9	10	11																						
<b>Poniedziałek</b> Mo / Mo / Lu / Pl	<b>Wtorek</b> Tu / Di / Ma / Br	<b>Środa</b> Wi / Mi / Me / Cp	<b>Czwartek</b> Th / Do / Gi / Tr	<b>Piątek</b> Fr / Ft / Ve / Fr	<b>Sobota</b> Sa / Sa / Sa / C6	<b>Niedziela</b> Su / So / Do / Hg																						
Agity, Adkijsy	Doroby, Tyusa	Ryzards, Romualda	TRUSTY CZWARTEK Jano, Piotra	Cyryli, Apolonii	OSTATNIA SOBOTA KARNIAWAŁU Jacka, Scholastyki	Łazarza, Bernacki																						
7	7	7	7	7	7	7																						
8	8	8	8	8	8	8																						
9	9	9	9	9	9	9																						
10	10	10	10	10	10	10																						
11	11	11	11	11	11	11																						
12	12	12	12	12	12	12																						
13	13	13	13	13	13	13																						
14	14	14	14	14	14	14																						
15	15	15	15	15	15	15																						
16	16	16	16	16	16	16																						
1	2	3	4	5	6	7	8	9	10	11	12	13	14	15	16	17	18	19	20	21	22	23	24	25	26	27	28	29



KALENDARZ / CALENDAR		505T	REGISTRY / INDEX		
format / format		297 × 105 mm biurkowy desk	drukowane printed	wycinane tabbed	perforacja narożników corner perforation
ilość stron / pages		128			
papier biały / white paper druk / print	szaro-bordowy grey-maroon				
	szaro-granatowy grey-dark blue				
	szaro-grafitowy grey-graphite	✓			
papier chamois/ ivory paper druk / print	szaro-bordowy grey-maroon				
	szaro-granatowy grey-dark blue				
	szaro-grafitowy grey-graphite	✓			
papier z recyklingu / recycled paper druk / print	szaro-grafitowy grey-graphite				
papier z trawy / grass paper druk / print	szaro-grafitowy grey-graphite				
papier z kamienia / stone paper druk / print	szaro-grafitowy grey-graphite				
język / language		PL GB DE IT UA			
dane personalne / personal data		✓			
licznik dni / day counter		✓			
numeracja tygodni / week numbering		✓			
karta planowania celów / goal planning sheet					
święta międzynarodowe / international holidays		✓			
kalendarz skrócony / shortened calendar 2023-2025		✓			
planer roczny / annual planner					
planer miesięczny / monthly planner					
kalendarz roczny / annual calendar 2024					
imieniny / name day		✓			
aforyzmy / aphorisms					
oświadczenie drogowe / accident statement					
notes / notebook		✓			
mapy / maps					





KALENDARZ / CALENDAR		509T	511T	512T	REGISTRY / INDEX		perforacja narożników corner perforation
format / format		149 × 203 mm ~A5	208 × 260 mm ~A4	167 × 240 mm ~B5	drukowane printed	wycinane tabbed	
ilość stron / pages		160	160	160			
papier biały / white paper druk / print	szaro-bordowy grey-maroon						
	szaro-granatowy grey-dark blue						
	szaro-grafitowy grey-graphite	✓	✓	✓			
papier chamois/ ivory paper druk / print	szaro-bordowy grey-maroon						
	szaro-granatowy grey-dark blue						
	szaro-grafitowy grey-graphite	✓		✓			
papier z recyklingu / recycled paper druk / print	szaro-grafitowy grey-graphite	✓		✓			
papier z trawy / grass paper druk / print	szaro-grafitowy grey-graphite	✓	✓	✓			
papier z kamienia / stone paper druk / print	szaro-grafitowy grey-graphite	✓	✓	✓			
język / language		PL GB DE IT UA					
dane personalne / personal data		✓	✓	✓			
licznik dni / day counter							
numeracja tygodni / week numbering		✓	✓	✓			
karta planowania celów / goal planning sheet		✓	✓	✓			
święta międzynarodowe / international holidays		✓	✓	✓			
kalendarz skrócony / shortened calendar 2023-2025		✓	✓	✓			
planer roczny / annual planner		✓	✓	✓			
planer miesięczny / monthly planner		✓	✓	✓			
kalendarz roczny / annual calendar 2024							
imieniny / name day		✓	✓	✓			
aforyzmy / aphorisms		✓	✓	✓			
oświadczenie drogowe / accident statement		✓	✓	✓			
notes / notebook		✓	✓	✓			
mapy / maps							

# 514T

FEBRUARY	Week 7	
12 Monday		
13 Tuesday		
14 Wednesday		
15 Thursday		
16 Friday		
17 Saturday		18 Sunday



KALENDARZ / CALENDAR		514T	REGISTRY / INDEX		
format / format		167 × 240 mm ~B5	drukowane printed	wycinane tabbed	perforacja narożników corner perforation
ilość stron / pages		160			
papier biały / white paper druk / print	szaro-bordowy grey-maroon				
	szaro-granatowy grey-dark blue				
	szaro-grafitowy grey-graphite	✓			
papier chamois/ ivory paper druk / print	szaro-bordowy grey-maroon				
	szaro-granatowy grey-dark blue				
	szaro-grafitowy grey-graphite				
papier z recyklingu / recycled paper druk / print	szaro-grafitowy grey-graphite				
papier z trawy / grass paper druk / print	szaro-grafitowy grey-graphite				
papier z kamienia / stone paper druk / print	szaro-grafitowy grey-graphite				
język / language		GB			
dane personalne / personal data		✓			
licznik dni / day counter					
numeracja tygodni / week numbering		✓			
karta planowania celów / goal planning sheet		✓			
święta międzynarodowe / international holidays		✓			
kalendarz skrócony / shortened calendar 2023-2025		✓			
planer roczny / annual planner		✓			
planer miesięczny / monthly planner		✓			
kalendarz roczny / annual calendar 2024					
imieniny / name day					
aforyzmy / aphorisms					
oświadczenie drogowe / accident statement					
notes / notebook		✓			
mapy / maps					

# BLOKI KALENDARZY TYGODNIOWYCH / WEEKLY CALENDARS LAYOUTS

## 516 167 × 240 mm



stonebook<sup>o</sup>



KALENDARZ / CALENDAR		516	REGISTRY / INDEX		
format / format		167 × 240 mm ~B5	drukowane printed	wycinane tabbed	perforacja narożników corner perforation
ilość stron / pages		160			
papier biały / white paper druk / print	szaro-bordowy grey-maroon				
	szaro-granatowy grey-dark blue				
	szaro-grafitowy grey-graphite	✓			
papier chamois/ ivory paper druk / print	szaro-bordowy grey-maroon				
	szaro-granatowy grey-dark blue				
	szaro-grafitowy grey-graphite				
papier z recyklingu / recycled paper druk / print	szaro-grafitowy grey-graphite				
papier z trawy / grass paper druk / print	szaro-grafitowy grey-graphite				
papier z kamienia / stone paper druk / print	szaro-grafitowy grey-graphite	✓			
język / language		GB			
dane personalne / personal data		✓			
licznik dni / day counter					
numeracja tygodni / week numbering					
karta planowania celów / goal planning sheet					
święta międzynarodowe / international holidays					
kalendarz skrócony / shortened calendar 2023-2025					
planer roczny / annual planner		✓			
planer miesięczny / monthly planner					
kalendarz roczny / annual calendar 2024		✓			
imieniny / name day					
aforyzmy / aphorisms					
oświadczenie drogowe / accident statement					
notes / notebook		✓			
mapy / maps					

# BLOKI NOTESOWE / NOTEBOOKS LAYOUTS

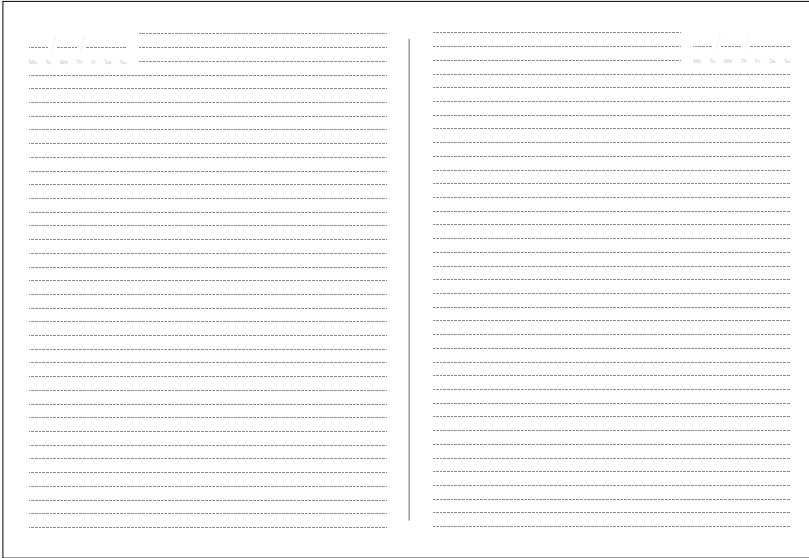

LINIA / LINE

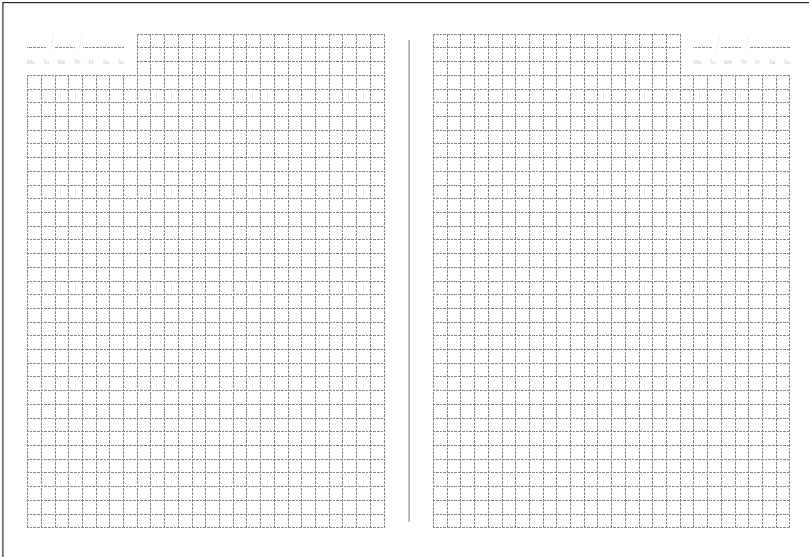

KRATKA / SQUARED

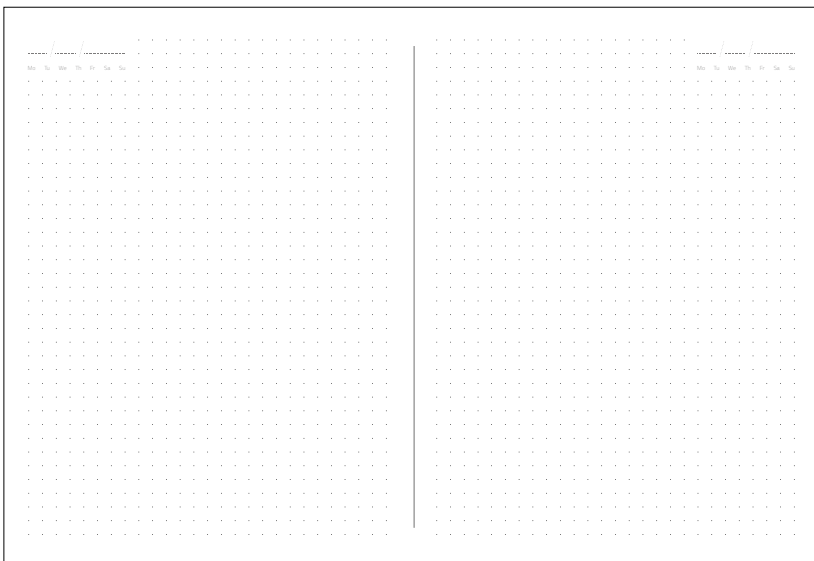

KROPKI / DOTS

NOTES / NOTEBOOK			~A6	~A5	~B5	~A4
format / format			105 × 140 mm	130 × 208 mm	167 × 240 mm	208 × 260 mm
ilość stron / pages			192	192	192	192
papier biały / white paper druk / print	grafitowy / graphite	linia / line	✓	✓	✓	
		kratka / squared	✓	✓	✓	✓
		kropki / dots		✓		
		gładki / plain	✓	✓		
papier chamois / ivory paper druk / print	grafitowy / graphite	linia / line		✓		
		kratka / squared		✓		
		kropki / dots				
		gładki / plain				
perforacja pionowa i pozioma na 16 ostatnich stronach / vertical and horizontal perforation of last 16 pages				✓	✓	✓

ilość stron / pages				192	192	
papier z recyklingu / recycled paper druk / print	grafitowy / graphite	linia / line				
		kratka / squared				
		kropki / dots		✓	✓	
		gładki / plain				
perforacja pionowa i pozioma na 16 ostatnich stronach / vertical and horizontal perforation of last 16 pages						

ilość stron / pages				144	144	
papier z trawy / grass paper druk / print	grafitowy / graphite	linia / line				
		kratka / squared		✓	✓	
		kropki / dots				
		gładki / plain				
perforacja pionowa i pozioma na 16 ostatnich stronach / vertical and horizontal perforation of last 16 pages						

ilość stron / pages				144	144	
papier z kamienia / stone paper druk / print	grafitowy / graphite	linia / line		✓	✓	
		kratka / squared		✓	✓	
		kropki / dots		✓		
		gładki / plain		✓		
perforacja pionowa i pozioma na 16 ostatnich stronach / vertical and horizontal perforation of last 16 pages						

język datownika / date stamp language	GB NIE DOTYCZY BLOKÓW NOTESOWYCH GŁADKICH / DOES NOT APPLY TO PLAIN NOTEBOOKS				
---------------------------------------	--	--	--	--	--



**GADŻETY WYKONANE Z TROSKĄ O ŚRODOWISKO ZE SŁOMY PSZENICZNEJ W POŁĄCZENIU Z ABS. / GADGETS MADE WITH CARE FOR THE ENVIRONMENT MADE OF WHEAT STRAW TOGETHER WITH ABS.**



**GADŻETY  
STWORZONE  
Z PSZENICY**

GADGETS  
MADE OUT  
OF WHEAT



# PSZENICA · BETON I BAMBUS

## WHEAT · CEMENT AND BAMBOO

SKOMPONUJ WŁASNY ECO SET / COMPOSE YOUR OWN ECO SET



### GŁOŚNIK BLUETOOTH / BLUETOOTH SPEAKER

słoma pszenicy + ABS / wheat straw + ABS

**G0009** numer katalogowy / catalogue number

- bluetooth / bluetooth: V 5.0
- głośnik / speaker: 3 W
- bateria / battery: 300 mAh
- mikrofon: prowadzenie rozmów w trybie zestawu głośnomówiącego / microphone: hands free calling
- wymiar / size: 87 × 72 × 40 mm
- metoda znakowania: druk UV / marking method: UV printing



### POWERBANK / POWERBANK

słoma pszenicy + ABS / wheat straw + ABS

**G0008** numer katalogowy / catalogue number

- bateria / battery: 5000 mAh
- kabel / cable: micro USB
- wejście / input: DC5V-2.0 A
- wyjście / output: DC5V-2.0 A
- wymiar / size: 94 × 63 × 14 mm
- metoda znakowania: druk UV / marking method: UV printing



### ŁADOWARKA INDUKCYJNA / WIRELESS CHARGER

słoma pszenicy + ABS / wheat straw + ABS

**G0012** numer katalogowy / catalogue number

- wejście / input: DC5V-2.0 A
- wyjście bezprzewodowe / wireless output: 5 W
- HUB 2 × USB
- wymiar / size: 90 × 90 × 9 mm
- metoda znakowania: druk UV / marking method: UV printing



### ROZGAŁĘŹNIK USB DŁUGI /

LONG USB CHARGING CABLE **NEW**

słoma pszenicy + ABS / wheat straw + ABS

- złącza / connectors:  
wejście / input **USB A/C**  
wyjście / output **USB Micro/C, Lightning (iPhone)**
- wymiar / size: **1185 × 34 × 9 mm**
- metoda znakowania: **druk UV (dwustronnie)** / marking method: UV print (on both sides)
- opakowanie / packaging\*\*

**G0011** numer katalogowy / catalogue number

- wstawka / insert: **pszenica** / wheat



**PODŚWIETLANE  
LOGO**

ILLUMINATED  
LOGO

### ROZGAŁĘŹNIK USB DŁUGI /

LONG USB CHARGING CABLE **NEW**

słoma pszenicy + ABS / wheat straw + ABS

- złącza / connectors:  
wejście / input **USB A/C**  
wyjście / output **USB Micro/C, Lightning (iPhone)**
- wymiar / size: **1185 × 34 × 9 mm**
- metoda znakowania: **grawer (jednostronnie)** / marking method: engraving (one side only)
- opakowanie / packaging\*\*

**G0029** numer katalogowy / catalogue number

- wstawka / insert: **biała** / white
- światło / light: **00** – białe / white



### ROZGAŁĘŹNIK USB DŁUGI /

LONG USB CHARGING CABLE **NEW**

słoma pszenicy + ABS + bambus /  
wheat straw + ABS + bamboo

- złącza / connectors:  
wejście / input **USB A/C**  
wyjście / output **USB Micro/C, Lightning (iPhone)**
- wymiar / size: **1185 × 34 × 9 mm**
- metoda znakowania: **druk UV (jednostronnie)** / marking method: UV print (one side only)
- opakowanie / packaging\*\*

**G0030** numer katalogowy / catalogue number

- wstawka / insert: **bambus** / bamboo

\*DOSTĘPNE OPAKOWANIA STR. 118-119. / AVAILABLE PACKAGING PP. 118-119.

\*\*OPAKOWANIE STANDARD DO ROZGAŁĘŹNIKÓW ECO STR. 108. / STANDARD PACKAGING FOR THE ECO CHARGING CABLE PAGE 108.



**PODŚWIETLANE  
LOGO**

ILLUMINATED  
LOGO



**ROZGAŁĘŹNIK USB DŁUGI /  
LONG USB CHARGING CABLE <sup>NEW</sup>**  
bambus + ABS / bamboo + ABS\*

- złącza / connectors:  
wejście / input USB A/C  
wyjście / output USB C,  
Lightning (iPhone)
- wymiar / size: 1220 × 35 × 10 mm
- metoda znakowania:  
grawer (jednostronnie) /  
marking method:  
engraving (one side only)
- opakowanie / packaging\*\*

**G0031** numer katalogowy /  
catalogue number

- wstawka / insert: czarna / black
- światło / light: 00 – białe / white

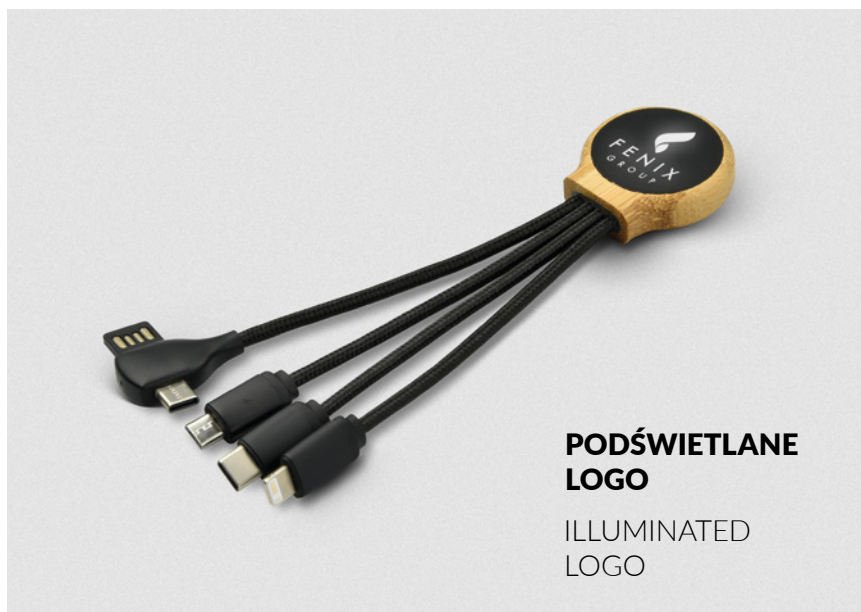

**PODŚWIETLANE  
LOGO**

ILLUMINATED  
LOGO

**ROZGAŁĘŹNIK USB KRÓTKI /  
SHORT USB CHARGING CABLE <sup>NEW</sup>**  
bambus + ABS / bamboo + ABS\*

- złącza / connectors:  
wejście / input USB A/C  
wyjście / output USB Micro/C,  
Lightning (iPhone)
- wymiar / size: 162 × 37 × 10 mm
- metoda znakowania:  
grawer (jednostronnie) /  
marking method: engraving  
(one side only)
- opakowanie / packaging\*\*

**G0032** numer katalogowy /  
catalogue number

- wstawka / insert: czarna / black
- światło / light: 00 – białe / white



**OPAKOWANIE STANDARD /  
STANDARD PACKAGING**

\*DOSTĘPNE OPAKOWANIA STR. 118-119. / AVAILABLE PACKAGING PP. 118-119.

\*\*OPAKOWANIE STANDARD DO ROZGAŁĘŹNIKÓW ECO STR. 108. / STANDARD PACKAGING FOR THE ECO CHARGING CABLE PAGE 108.



**ŁADOWARKA INDUKCYJNA STOJĄCA /**  
STAND WIRELESS CHARGER  
cement + bambus / cement + bamboo

**G0015** numer katalogowy / catalogue number

- wejście / input: DV5V-2 A
- wyjście bezprzewodowe / wireless output: 5 W
- wymiar / size: 124 × 98 × 98 mm
- metoda znakowania: druk UV / marking method: UV printing



**ŁADOWARKA INDUKCYJNA / WIRELESS CHARGER** **NEW**  
bambus + rPET / bamboo + rPET

**G0065** numer katalogowy / catalogue number

- wejście / input: DC 9V/2A, 12V/1.5A, 5V/2A,
- złącza /connectors: wejście / input USB A/C
- wyjście bezprzewodowe / wireless output: 15 W
- wymiar / size: 130 × 65 × 10 mm
- metoda znakowania: druk UV / marking method: UV printing



**ŁADOWARKA INDUKCYJNA STOJĄCA / STAND WIRELESS CHARGER** **NEW**  
bambus + rPET / bamboo + rPET

**G0066** numer katalogowy / catalogue number

- wejście / input: DC 9V/2A, 12V/1.5A, 5V/2A,
- złącza /connectors: wejście / input USB A/C
- wyjście bezprzewodowe / wireless output: 15 W
- wymiar / size: 155 × 100 × 10 mm
- metoda znakowania: druk UV / marking method: UV printing



**ECO BOX 3**

ŁADOWARKA INDUKCYJNA G0012 +  
POWERBANK G0008 / WIRELESS CHARGER G0012  
+ POWERBANK G0008



**ECO BOX 4**

POWERBANK G0008 + GŁOŚNIK BLUETOOTH  
G0009 / POWERBANK G0008 + BLUETOOTH  
SPEAKER G0009



**ECO BOX 5**

ŁADOWARKA INDUKCYJNA G0012 +  
GŁOŚNIK BLUETOOTH G0009 /  
WIRELESS CHARGER G0012 +  
BLUETOOTH SPEAKER G0009



**ECO BOX 7** NEW

POWERBANK G0008 + ROZGAŁĘŻNIK USB  
DŁUGI G0029 / POWERBANK G0008 + LONG USB  
CHARGING CABLE G0029



**ECO BOX 8** NEW

POWERBANK G0008 + ROZGAŁĘŻNIK USB DŁUGI  
G0011 / POWERBANK G0008 + LONG USB  
CHARGING CABLE G0011



**ECO BOX 9** NEW

GŁOŚNIK BLUETOOTH G0009 + ROZGAŁĘŻNIK  
USB DŁUGI G0011 / BLUETOOTH SPEAKER G0009 +  
LONG USB CHARGING CABLE G0011

## GADŻETY ECO / ECO GADGETS



### **POWER SET KRAFT 1** NEW

POWERBANK G0008 + ROZGAŁĘŻNIK  
USB DŁUGI G0011 /  
POWERBANK G0008 + LONG USB  
CHARGING CABLE G0011



### **POWER SET KRAFT 2** NEW

POWERBANK G0008 + ROZGAŁĘŻNIK  
USB DŁUGI G0029 /  
POWERBANK G0008 + LONG USB  
CHARGING CABLE G0029



### **POWER SET KRAFT 3** NEW

POWERBANK G0008 + ROZGAŁĘŻNIK  
USB DŁUGI G0030 /  
POWERBANK G0008 + LONG USB  
CHARGING CABLE G0030





### **ECO SET 3**

NOTES A5 + ŁADOWARKA INDUKCYJNA G0012 + POWERBANK G0008 /  
A5 NOTEBOOK + WIRELESS CHARGER G0012 + POWERBANK G0008



### **ECO SET 4**

NOTES A5 + POWERBANK G0008 + GŁOŚNIK BLUETOOTH G0009 /  
A5 NOTEBOOK + POWERBANK G0008 + BLUETOOTH SPEAKER G0009



### **ECO SET 5**

NOTES A5 + ŁADOWARKA INDUKCYJNA G0012 + GŁOŚNIK BLUETOOTH G0009 /  
A5 NOTEBOOK + WIRELESS CHARGER G0012 + BLUETOOTH SPEAKER G0009

## GADŻETY ECO / ECO GADGETS

### ECO SET 7

NOTES A5 + ŁADOWARKA INDUKCYJNA  
G0015 / A5 NOTEBOOK + WIRELESS  
CHARGER G0015



### ECO SET 8 **NEW**

NOTES A5 + ŁADOWARKA INDUKCYJNA  
STOJĄCA G0066 / A5 NOTEBOOK +  
STAND WIRELESS CHARGER G0066



**ECO SET 9** NEW

NOTES A5 + ROZGAŁĘŻNIK USB DŁUGI G0031 +  
DŁUGOPIS G0073 / A5 NOTEBOOK + LONG USB  
CHARGING CABLE G0031 + PEN G0073



## ROZGAŁĘŹNIKI USB / USB CHARGING CABLES



### PODŚWIETLANE LOGO

ILLUMINATED  
LOGO

### ROZGAŁĘŹNIK USB KRÓTKI / SHORT USB CHARGING CABLE

- cztery porty zgodne z / four connectors compatible with: USB, Micro USB, USB C, Lightning (iPhone)
- wymiar / size: 160 × 35 × 10 mm
- metoda znakowania: grawer (dwustronnie) / marking method: engraving (on both sides)

**G0026** numer katalogowy / catalogue number

- kolor / colour: granatowy / navy blue
- światło / light: **00** – białe / white

**G0027** numer katalogowy / catalogue number

- kolor / colour: czerwony / red
- światło / light: **00** – białe / white

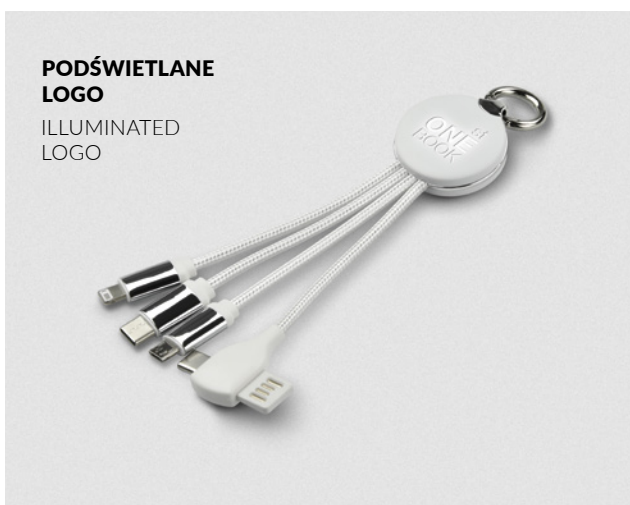

### PODŚWIETLANE LOGO

ILLUMINATED  
LOGO

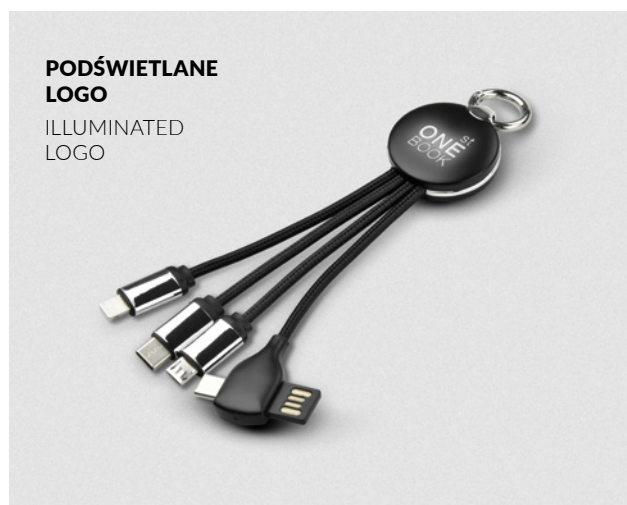

### PODŚWIETLANE LOGO

ILLUMINATED  
LOGO

### ROZGAŁĘŹNIK USB KRÓTKI / SHORT USB CHARGING CABLE

- złącza / connectors: wejście / input USB A/C, wyjście / output USB Micro/C, Lightning (iPhone)
- wymiar / size: 153 × 35 × 10 mm
- metoda znakowania / marking method:  
grawer (dwustronnie) / engraving (on both sides) – **G0067, G0068**  
druk UV (dwustronnie) / UV print (on both sides) – **G0067**

**G0067** numer katalogowy / catalogue number

- kolor / colour: biały / white
- światło / light: **00** – białe / white, **02** – czerwone / red, **03** – pomarańczowe / orange

**G0068** numer katalogowy / catalogue number

- kolor / colour: czarny / black
- światło / light: **00** – białe / white, **02** – czerwone / red, **07** – niebieskie / blue

**DRUK UV  
Z PODŚWIETLANYMI  
ELEMENTAMI**

UV PRINT  
WITH ILLUMINATED  
ELEMENTS



**PODŚWIETLANE  
LOGO**

ILLUMINATED  
LOGO



**PODŚWIETLANE  
LOGO**

ILLUMINATED  
LOGO



**ROZGAŁĘŹNIK USB DŁUGI / LONG USB CHARGING CABLE**

- złącza / connectors: wejście / input USB A/C, wyjście / output USB Micro/C, Lightning (iPhone)
- wymiar / size: 1205 × 34 × 9 mm
- metoda znakowania / marking method:
  - grawer (jednostronnie) / engraving (one side only) – **G0069, G0070**
  - druk UV (jednostronnie) / UV print (one side only) – **G0069**

**G0069** numer katalogowy / catalogue number

- kolor / colour: biały / white
- światło / light: **00** – białe / white

**G0070** numer katalogowy / catalogue number

- kolor / colour: czarny / black
- światło / light: **00** – białe / white

## ROZGAŁĘŻNIKI USB / USB CHARGING CABLES

### OPAKOWANIE NA ROZGAŁĘŻNIKI / PACKAGING FOR USB CHARGING CABLES

FOLIA Z DRUKOWANYM DWUSTRONNIE KARTONIKIEM WG AUTORSKIEGO PROJEKTU  
FOIL WITH PRINTED CARDBOARD ON BOTH SIDES ACCORDING TO CUSTOMISED DESIGN

- wymiar (rozgałęźnik krótki) / size (short charging cable): 198 × 70 mm
- wymiar (rozgałęźnik długi) / size (long charging cable): 230 × 70 mm



### PAPIER BARWIONY W MASIE / MASS DYED PAPER

- wymiar (rozgałęźnik krótki) / size (short charging cable): 180 × 53 × 16 mm
- wymiar (rozgałęźnik długi) / size (long charging cable): 210 × 60 × 25 mm

#### OPAKOWANIE NA ROZGAŁĘŻNIK DŁUGI PACKAGING FOR LONG CHARGING CABLE



#### OPAKOWANIE NA ROZGAŁĘŻNIK KRÓTKI PACKAGING FOR SHORT CHARGING CABLE

**OPAKOWANIE NA ROZGAŁĘŻNIK DŁUGI Z NADRUKIEM**  
PACKAGING FOR LONG CHARGING CABLE WITH PRINT



**OPAKOWANIE NA ROZGAŁĘŻNIK KRÓTKI Z NADRUKIEM**  
PACKAGING FOR SHORT CHARGING CABLE WITH PRINT

**PAPIER BARWIONY W MASIE LUB KRAFTOWY Z NADRUKIEM CZARNYM /**  
MASS DYED PAPER OR KRAFT WITH BLACK PRINT **NEW**

- wymiar (rozgałęźnik krótki) / size (short charging cable): 180 × 60 × 20 mm
- wymiar (rozgałęźnik długi) / size (long charging cable): 215 × 70 × 20 mm

**OPAKOWANIE NA ROZGAŁĘŻNIK DŁUGI Z NADRUKIEM CZARNYM**  
PACKAGING FOR LONG CHARGING CABLE WITH BLACK PRINT



**OPAKOWANIE NA ROZGAŁĘŻNIK KRÓTKI Z NADRUKIEM CZARNYM**  
PACKAGING FOR SHORT CHARGING CABLE WITH BLACK PRINT

## POWERBANKI / POWERBANKS



### POWERBANK / POWERBANK

**G0003** numer katalogowy / catalogue number

- kolor / colour: **01** – czarny / black, **02** – czerwony / red, **08** – granatowy / navy blue
- pojemność baterii / battery capacity: **4000 mAh**
- czterostopniowy poziom naładowania / four stage charging level
- żywotność: ok. 500 ładowań / number of charging cycles: approx 500
- wejście / input: Micro USB
- wyjścia / output: USB × 2
- wymiar / size: **138 × 66 × 9 mm**
- metoda znakowania: grawer (jednostronnie) / marking method: engraving (one side only)

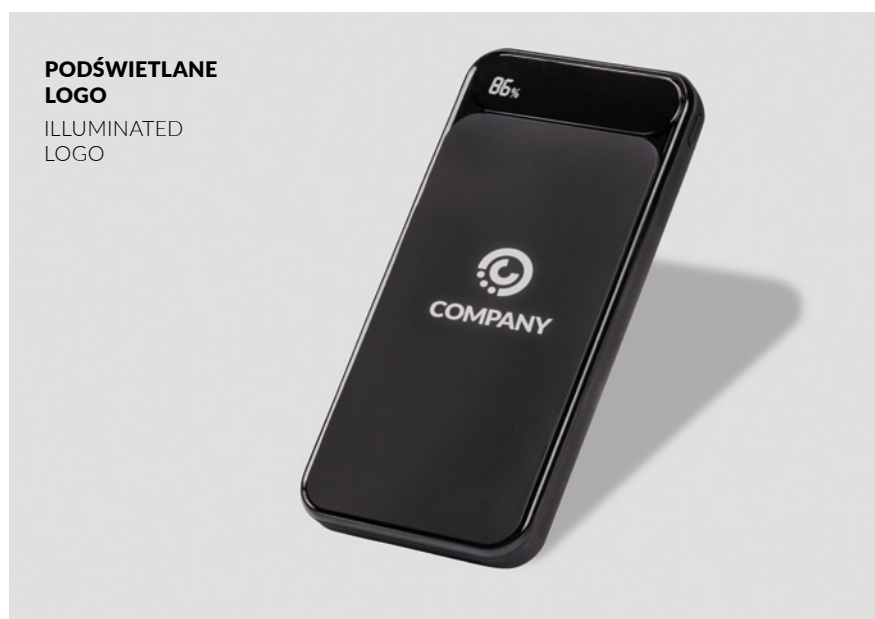

### POWERBANK / POWERBANK **NEW**

**G0074** numer katalogowy /  
catalogue number

- kolor / colour: **01** – czarny / black
- pojemność baterii / battery capacity: **10 000 mAh**
- wyświetlacz cyfrowy: procent naładowania / digital display: charge percentage
- żywotność: ok. 500 ładowań / number of charging cycles: approx 500
- wejście / input: Micro USB, USB C - DC5V/2A
- wyjścia / output: USB x2 - DC5V/2A (maks. 2,1A)
- wymiar / size: **132,1 × 67 × 20,6 mm**
- metoda znakowania: grawer (jednostronnie) / marking method: engraving (one side only)



## ENERGY SET



## ENERGY SET





**KALENDARZ/NOTES + POWERBANK + ROZGAŁĘŻNIK USB KRÓTKI /**  
**CALENDAR/NOTEBOOK + POWERBANK + SHORT USB CHARGING CABLE**

**kolor zestawu / set colour**

**czarny / black**  
**granatowy / navy blue**  
**czerwony / red**

**kalendarz lub notes / calendar or notebook**

**503D, 509T, 510D – kalendarz / calendar**  
**lub / or**  
**A5 – notes / notebook**

**opakowanie / packaging**

**czarny papier barwiony w masie / black mass dyed paper**

**znakowanie opakowania / marking method of the packaging**

**sitodruk / silk-screen**

## POWER SET

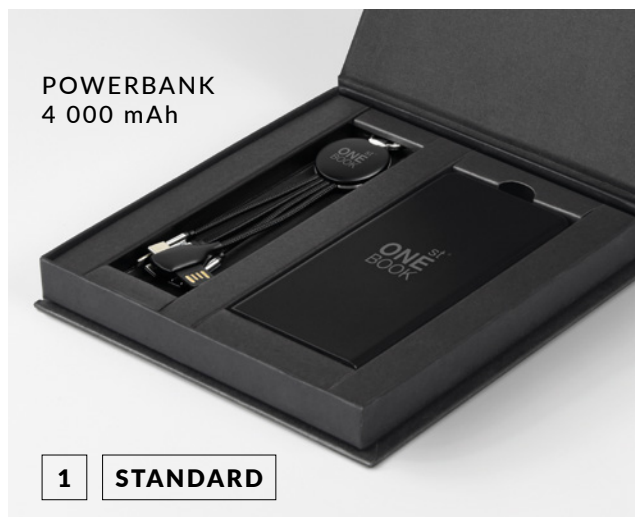

POWERBANK + ROZGAŁĘŹNIK USB KRÓTKI / POWERBANK + SHORT USB CHARGING CABLE

kolor zestawu / set colour

opakowanie / packaging

znakowanie opakowania / marking method of the packaging

czarny / black  
czerwony / red  
granatowy / navy blue  
czarny / black **NEW**

w kolorze zestawu / in the set colour

sitodruk / silk-screen



POWERBANK  
4 000 mAh

5 LONG

**NEW**

POWERBANK  
10 000 mAh

6 LONG PLUS

POWERBANK + ROZGAŁĘŻNIK USB DŁUGI / POWERBANK + LONG USB CHARGING CABLE

kolor zestawu / set colour

czarny / black

opakowanie / packaging

w kolorze zestawu / in the set colour

znakowanie opakowania / marking method of the packaging

sitodruk / silk-screen

WHITE BOX & BLACK BOX





**NOTES + ROZGAŁĘŹNIK USB STANDARD + OZDOBNE PUDEŁKO WIECZKOWE /**  
**NOTEBOOK + USB CHARGING CABLE + DECORATIVE LID BOX**

**kolor zestawu / set colour**

**czarny / black**

**biały / white**

**kalendarz lub notes / calendar or notebook**

**pod każdy format z wykluczeniem kalendarza 501D, 505T /**  
**for any format except 501D, 505T calendar**

**kolor rozgałęźnika / charger colour**

**biały / white**

**czarny / black**

**opakowanie / packaging**

**papier barwiony w masie czarny / black mass dyed paper**

**karton biały / white cardboard**

# ZESTAWIENIE BLOKÓW / LIST OF BLOCKS

## KALENDARZ DZIENNY / DAILY CALENDAR

BLOK BLOCK	ILOŚĆ STRON NUMBER OF PAGES	FORMAT BLOKU BLOCK FORMAT	PAPIER / PAPER				PLANER MIESIĘCZNY MONTHLY PLANNER	PERFORACJA NAROŻNA CORNER PERFORATION	AFORYZMY APHORISMS	REGISTRY / INDEX	
			BIAŁY WHITE	CHAMOIS IVORY	Z RECYKLINGU RECYCLED	DRUK PRINT*				WYCINANE TABBED	DRUKOWANE PRINTED
501D	368	200 × 280 mm	✓	✓		●●●	✓	✓	✓	✓	✓
503D	368	143 × 203 mm	✓	✓		●●●	✓	✓	✓	✓	✓
503D	368	143 × 203 mm			✓	●●	✓		✓		✓
506D	368	110 × 160 mm	✓			●●	✓		✓		✓
508D	368	162 × 240 mm	✓	✓		●●●	✓	✓	✓	✓	✓
510D	368	143 × 203 mm	✓			●●	✓				✓

\* ●● / ●●● / ●●● kolor druku / print colour

## KALENDARZ TYGODNIOWY / WEEKLY CALENDAR

BLOK BLOCK	ILOŚĆ STRON NUMBER OF PAGES	FORMAT BLOKU BLOCK FORMAT	PAPIER / PAPER					DRUK PRINT*	PLANER MIESIĘCZNY MONTHLY PLANNER	PERFORACJA NAROŻNA CORNER PERFORATION	AFORYZMY APHORISMS	REGISTRY / INDEX	
			BIAŁY WHITE	CHAMOIS IVORY	Z RECYKLINGU RECYCLED	Z TRAWY GRASS	Z KAMIENIA STONE					WYCINANE TABBED	DRUKOWANE PRINTED
502T	160	208 × 260 mm	✓	✓				●●●	✓	✓	✓	✓	✓
504T	128	84 × 151 mm	✓	✓				●●					✓
505T	128	297 × 105 mm	✓	✓				●●					
507T	160	167 × 240 mm	✓	✓				●●●	✓	✓	✓	✓	✓
					✓			●●		✓		✓	✓
509T	160	149 × 203 mm	✓	✓	✓	✓	✓	●●		✓			
511T	160	208 × 260 mm	✓			✓	✓	●●		✓		✓	
512T	160	167 × 240 mm	✓		✓	✓	✓	●●		✓		✓	
514T	160	167 × 240 mm	✓					●●		✓			

\* ●● / ●●● / ●●● kolor druku / print colour

## KALENDARZ ROCZNY Z NOTESEM / ANNUAL CALENDAR WITH NOTEBOOK

BLOK BLOCK	ILOŚĆ STRON NUMBER OF PAGES	FORMAT BLOKU BLOCK FORMAT	PAPIER / PAPER		
			BIAŁY WHITE	Z KAMIENIA STONE	DRUK PRINT*
516	160	167 × 240 mm	✓	✓	●●

\* ●● kolor druku / print colour

## NOTES / NOTEBOOK

BLOK BLOCK	ILOŚĆ STRON NUMBER OF PAGES	FORMAT BLOKU BLOCK FORMAT	PAPIER / PAPER					GŁADKI PLAIN	LINIA LINE	KRATKA SQUARED	KROPKI DOTS	PERFORACJA PERFORATION**
			BIAŁY WHITE	CHAMOIS IVORY	Z RECYKLINGU RECYCLED	Z TRAWY GRASS	Z KAMIENIA STONE					
A6	192	105 × 140 mm	✓					●	✓	✓	✓	
A5	192	130 × 208 mm	✓					●	✓	✓	✓	✓
	192	130 × 208 mm		✓				●		✓	✓	✓
	192	130 × 208 mm			✓			●			✓	
	144	130 × 208 mm				✓		●			✓	
	144	130 × 208 mm					✓	●	✓	✓	✓	
B5	192	167 × 240 mm	✓					●	✓	✓		✓
	192	167 × 240 mm			✓			●			✓	
	144	167 × 240 mm				✓		●		✓		
	144	167 × 240 mm					✓	●	✓	✓		
A4	192	208 × 260 mm	✓					●		✓		✓

\* ●● kolor druku / print colour

\*\*PERFORACJA PIONOWA I POZIOMA NA 16 OSTATNICH STRONACH / VERTICAL AND HORIZONTAL PERFORATION OF LAST 16 PAGES

Ze względu na ograniczenia wynikające z techniki druku, rzeczywiste kolory poszczególnych towarów mogą nieznacznie różnić się od kolorów prezentowanych na zdjęciach. Podane wymiary są wymiarami orientacyjnymi i nie mogą stanowić podstawy reklamacji. Producent zastrzega sobie prawo do technicznych zmian poszczególnych produktów, a także nie ponosi odpowiedzialności za ewentualne błędy w druku. Wszystkie znaki firmowe zamieszczone w katalogu są własnością ich autorów i zaprezentowane są jedynie w celach poglądowych. Katalog nie stanowi oferty w myśl przepisów kodeksu cywilnego. Produkcja w Polsce. / Due to restrictions of printing techniques, actual colours may slightly vary from the ones presented in the catalogue. The sizes and formats provided are for reference only and cannot be the subject of complaint. The manufacturer reserves the right to technical modifications, as well as is not responsible for any possible printing errors. All the trademarks that appear in the catalogue are the property of their authors and are presented for reference only. The catalogue does not constitute an offer within the meaning of the Civil Code. Made in Poland.